

Setup Manual

CONPROSYS series

Configurable Type

CONTENTS	
Introduction.....	4
Safety Precautions.....	7
Product Nomenclature and Function.....	10
Hardware Setup.....	15
CONPROSYS WEB Setting	20
Set the Computer Network.....	24
Installation.....	39
Connecting with CODESYS	47
Appendix.....	53

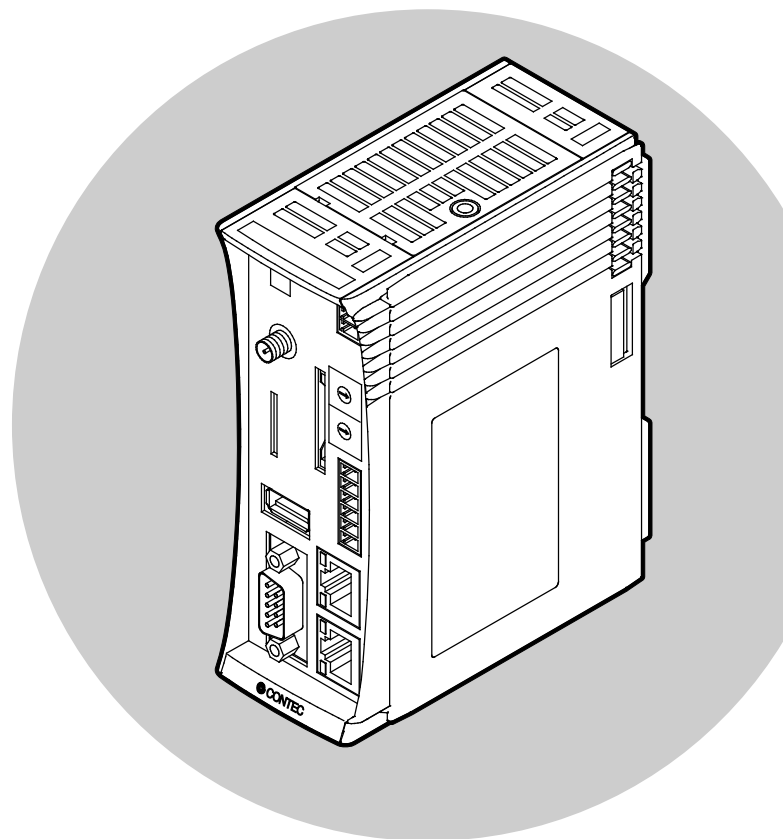

Table of Contents

Introduction 4

1. Related Manuals.....5
2. Online Help6

Safety Precautions 7

1. Safety Information.....8
2. Handling Precautions.....9

Product Nomenclature and Function..... 10

1. Nomenclature of Product Components 11
2. Description of Product Components 13
 1. Power Connector..... 13
 2. Rotary Switch 13
 3. Digital Input/Digital Output Connector 14

Hardware Setup 15

1. Insert SIM Card..... 16
2. Set Antenna 18
3. DIP switch 19

CONPROSYS WEB Setting..... 20

1. CONPROSYS WEB Setting Outline..... 21
 1. Compatible Web Browser 21
 2. CONPROSYS WEB Setting Operation..... 21
2. Menu Function List 22

Set the Computer Network 24

1. Items to Set Up..... 25
2. Connectors for Setup 26
3. Connect with a PC 27
4. Set the Computer Network..... 29
 1. Computer Network Setting Procedure (for Windows 10)..... 29
5. Check Communication 32
6. Check Operation 33

Installation 39

1. Install the Product 40
 1. Installation Conditions 40

Table of Contents

2. Mounting on a DIN Rail.....	43
3. Setting the Configurable Type Module.....	45

Connecting with CODESYS 47

1. Using CODESYS.....	48
1. How to obtain the CODESYS development environment.....	48
2. Installation of CODESYS Package.....	50
3. Connecting to pre-installed system (PLC controller).....	51

Appendix 53

1. Useful functions.....	54
1. Task processing function (CONPROSYS VTC).....	54
2. Work Area.....	54
3. Create Processing Tasks.....	55
4. Basic Procedure for Creating Processing Tasks.....	56
2. Monitoring Edit.....	59
1. Monitoring function (CONPROSYS HMI).....	59
2. Work Areas.....	59
3. Create a Monitoring Screen.....	60
4. Basic Procedure for Creating a Monitoring Screen.....	60

Introduction



This setup manual provides information on the basic settings and installations of the product.

This chapter lists the related manuals and the purposes.





1. Related Manuals

The manuals related to the product are listed below.
Read them as necessary along with this document.

◆ Must Read the Followings.

Name	Purpose	Contents	How to get
Product Guide	Must read this after opening the package.	This lists the product configuration and describes the precautions.	Included in the package (Printed matter)
Setup Manual	Read this when setting up the product.	This describes the required items for setup and configuration procedure.	 Download from the Contec website (PDF)
Reference Manual (Hardware)	Read this when operating the product.	This describes the hardware aspects such as functions and settings.	 Download from the Contec website (PDF)
Reference Manual (Software) (or System Setup Guide)	Read this when setting up the "CONPROSYS WEB Setting"	This describes how to set each function of "CONPROSYS WEB Setting".	 Download from the Contec website (PDF)

◆ Read the Followings as Necessary.

Name	Purpose	Contents	How to get
CONPROSYS Cloud Data Service 2 (CDS2) Manual	Read this to understand the outline of the CONPROSYS Cloud Data Service 2.	This describes the outline and specification of the CONPROSYS Cloud Data Service 2 as well as how to operate the product.	 Download from the Contec website (PDF)
CONPROSYS Cloud Data Service 2 Concise Manual	Read this when using the CONPROSYS Cloud Data Service 2.	This describes the procedure to start monitoring measured data in Cloud Data Service 2.	 Download from the Contec website (PDF)
CONPROSYS Java Applet Application Guide (For firmware version 2.00 or earlier)	Read this when using the system setting function of Java Applet application version.	This describes how to create a monitoring page and processing task with the system setting function in Java Applet application version.	 Download from the Contec website (PDF)
SIM Card Manual (With 3G model)	Read this when using the product with SIM card.	This describes the procedure to start sending data to Cloud server from M2M controller.	 Download from the Contec website (PDF)

◆ Download Manuals

Download the manuals accordingly from the following URL.

Download <https://www.contec.com/download/>

2. Online Help

We offer the detailed information on "CONPROSYS VTC" for assembling processing tasks such as calculation and control as well as on "CONPROSYS HMI" for operating and editing the monitoring screen through the Online Help.

Consult the Online Help as necessary.

◆ CONPROSYS VTC (Visual Task Control).

Online Help

<http://data.conprosys.com/help/task/V1/en/>

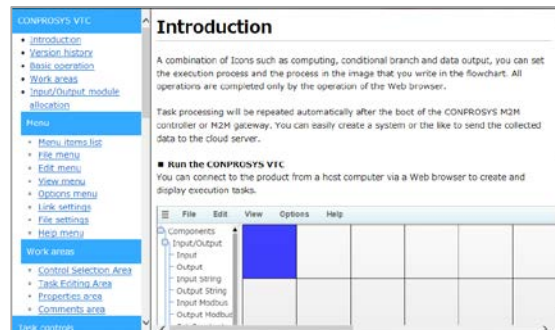

◆ CONPROSYS HMI (Human Machine Interface)

Online Help

<http://data.conprosys.com/help/hmi/V1/en/>

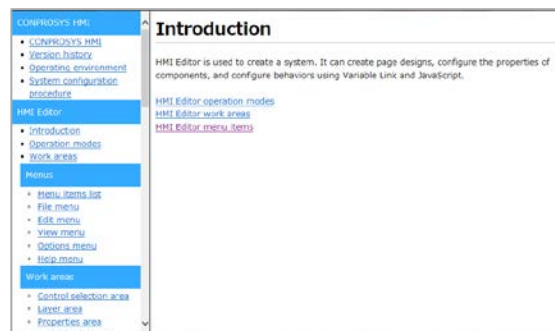

Safety Precautions



Understand the following definitions and precautions to use the product safely.

Never fail to read them before using the product.

1. Safety Information

This document provides safety information using the following symbols to prevent accidents resulting in injury or death and the destruction of equipment and resources.

Understand the meanings of these labels to operate the equipment safely.

 DANGER	DANGER indicates an imminently hazardous situation which, if not avoided, will result in death or serious injury.
 WARNING	WARNING indicates a potentially hazardous situation which, if not avoided, could result in death or serious injury.
 CAUTION	CAUTION indicates a potentially hazardous situation which, if not avoided, may result in minor or moderate injury or in property damage.

2. Handling Precautions

Refer to [Handling Precautions] in the “Reference Manual (Hardware)” of the each model for handling details.

Product Nomenclature and Function

This chapter describes product component names and their functions, pin assignment of each connector.

1. Nomenclature of Product Components

Component names of the product are shown in the figure below.

This example is the configurable type M2M controller CPS-MCS341G-DS1-130.

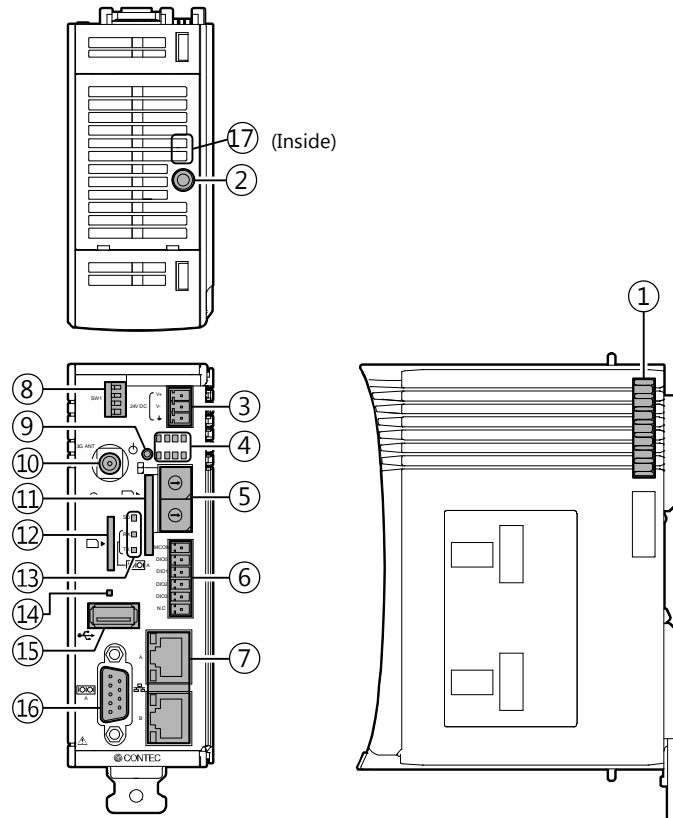

No.	Name	Function
1	Stack Bus	This is used for power supply and communication with the configurable type module.
2	Maintenance Connector	Do not use it.
3	Power Connector	Use the 3-pin connector, included in the package.
4	LED Indicator 1	This indicates the status of the product.
5	Rotary Switch	Used for user setup.
6	Digital I/O Connector	This is a connector for digital I/O. (Use the 6-pin connector, included in the package)
7	LAN Port	This is a connector for LAN.
8	DIP Switch	This is used for user setup.
9	Power Switch	This is used for controlling of the power supply.
10	Antenna Connector	This is a connector to connect an antenna. Use the supplied connector or optional one.
11	SD Card Slot	This a slot for inserting SD card to store data.
12	SIM Card Slot	It is a slot for inserting SIM card.
13	LED Indicator 2	This indicates the status of the product.
14	3G LED	Display the intensity of the signal reception.

No.	Name	Function
15	USB Port	This is a TYPE-A USB port.
16	RS-232C Serial Port	This is a RS-232C serial ports (male).
17	DIP Switch 2	This is used to run SDK

This example is the configurable type I/O module CPS-DIO-0808L.

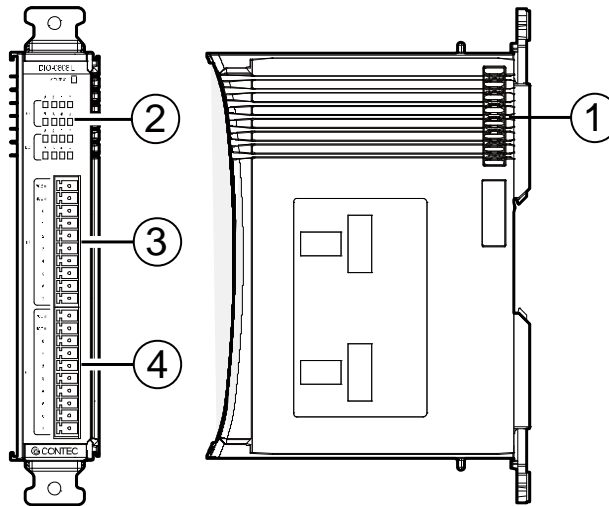

No.	Name	Function
1	Stack Bus	Used for power supply and communication with the configurable type module.
2	LED Indicator	This indicates the status of the product.
3	Digital Input	This is a connector for digital input. (Use the 10-pin connector, included in the package)
4	Digital Output	This is a connector for digital output. (Use the 10-pin connector, included in the package)

2. Description of Product Components

Main connectors used in the product are described.

*Refer to the "Reference Manual (Hard ware)" of each model for unlisted connectors.

1. Power Connector

Use the 3-pin connector, included in the package, to connect to external power.

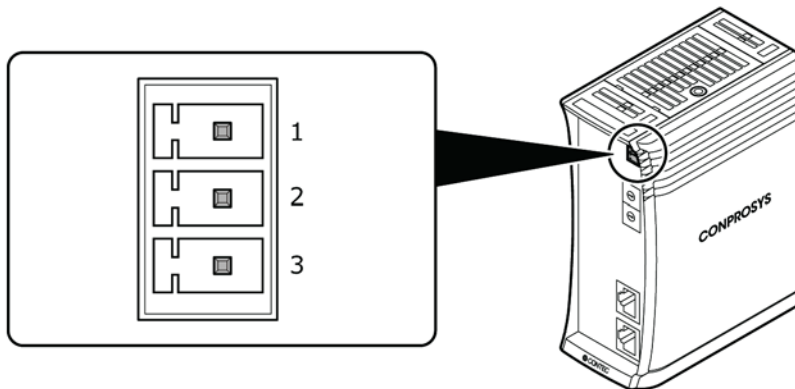

Pin Assignment

Pin No.	Signal Name	Description
1	V+	24VDC
2	V-	Ground
3	FG	Frame Ground

2. Rotary Switch

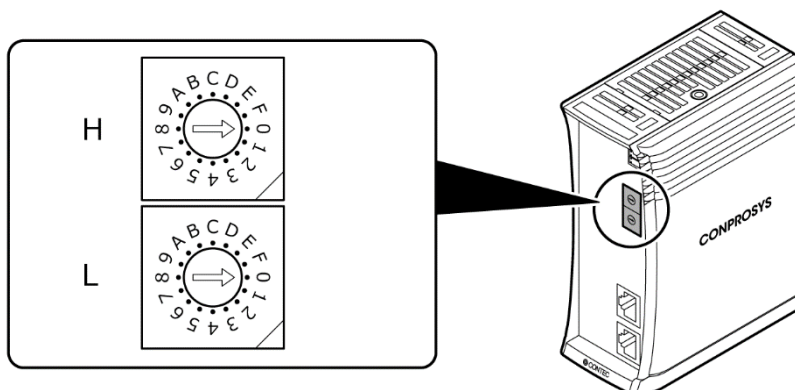

ID	Description
H	System Reservation: Always set to 0
L	System Reservation: Always set to 0

3. Digital Input/Digital Output Connector

This product has 4 channels of digital input and 4 channels of digital output.

You can switch them as digital input or digital output.

Use the 6-pin connector, included in the package to connect to external power.

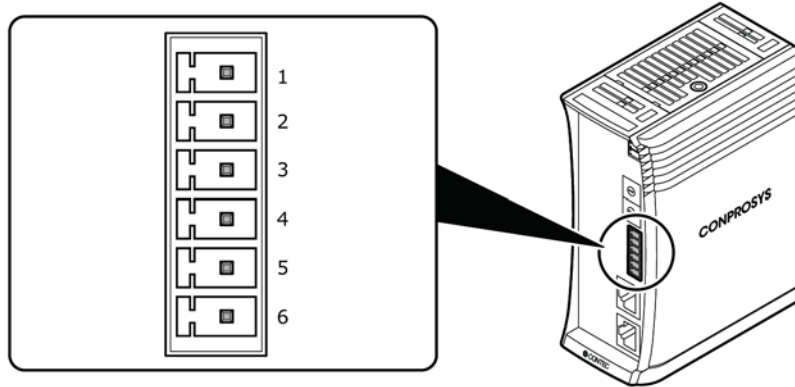

Pin Assignment

Pin No.	Signal Name	Description
1	MCOM	This connects the negative-side of the external power and shares with 4 channels of I/O signals.
2	DIO0	I/O signal It connects output signals as digital input, and connects input signals as digital output from other devices.
3	DIO1	I/O signal It connects output signals as digital input, and connects input signals as digital output from other devices.
4	DIO2	I/O signal It connects output signals as digital input, and connects input signals as digital output from other devices.
5	DIO3	I/O signal It connects output signals as digital input, and connects input signals as digital output from other devices.
6	N.C.	This pin is left unconnected.

Hardware Setup

This chapter describes how to set hardware including supplied items and switches.

1.Insert SIM Card

When communicating through 3G network with SIM card, follow the steps described below to insert SIM card.

SIM card is required individually.

Visit the CONTEC website to find the compatible card with the product.

Website <https://www.contec.com/>

- 1** Unfasten the screw of the cover.
(Card cover is attached to the product upon shipping).

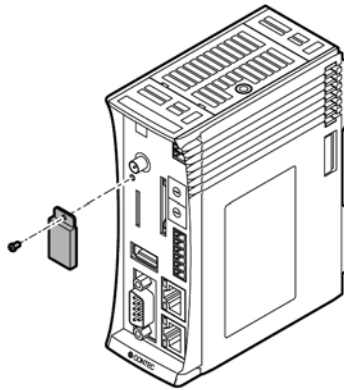

- 2** With the terminal side set in the position as follows, insert the SIM card all the way into the slot.

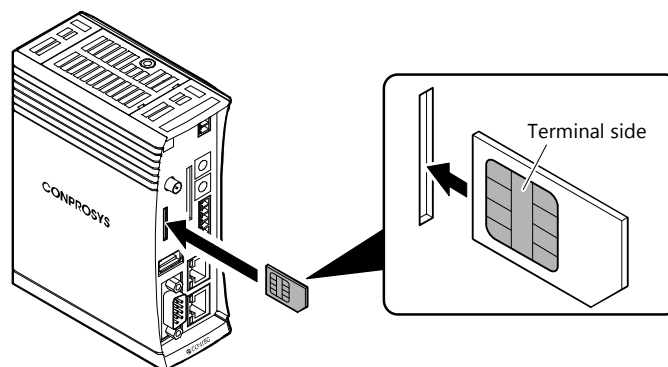

CAUTION

- Use a standard size (miniSIM) SIM card.
Standard SIM size: 25x15(mm)
- Do not use a Micro or Nano size SIM card with an adapter to make it as a standard SIM card.

3 Fasten the card cover with a screw.

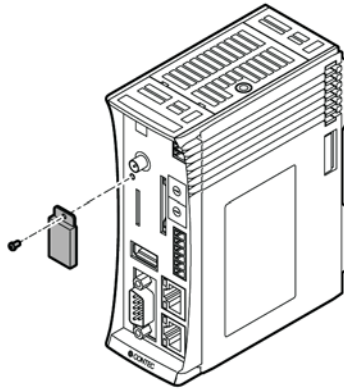

*Reverse the procedure described in the "**Insert SIM Card** " to remove the card.

*Tightening torque of the card cover is 3.5 kgF. Cm.

2.Set Antenna

Set the supplied antenna to the antenna connector. Turn the antenna in the direction of the arrow shown to fasten.

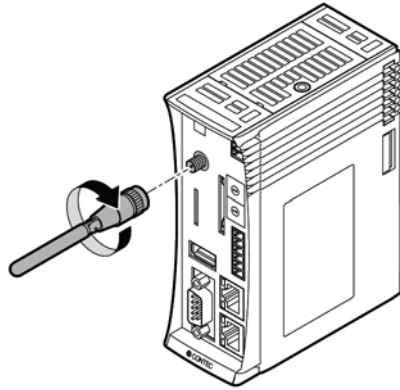

3.DIP switch

DIP Switch 1

It is used for user setup.

The factory default of all switches are set to "OFF".

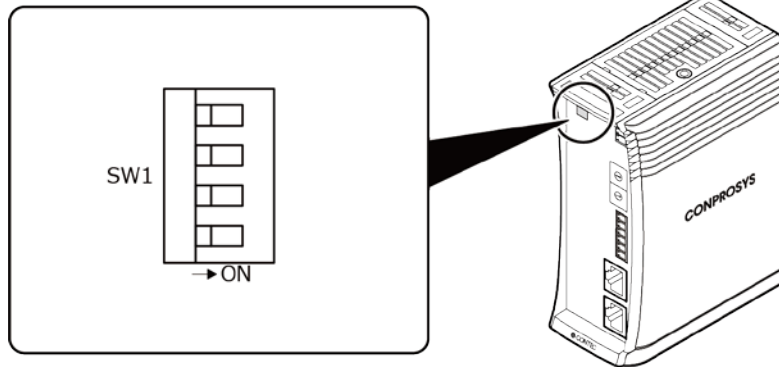

SW	Bit No.	Description
SW1	4	System Reservation: Always OFF
	3	2: OFF, 3: OFF This indicates it is set in the default setting.
		2: ON, 3: OFF IP address setting starts up with default setting upon turning on, while user/password and group settings starts up with a user's settings.
	2	2: ON, 3: ON The current IP address, user/password and group settings can be checked on the Web monitor.
1	2: ON, 3: ON Each setting will be initialized upon turning on. LED PWR and ST1 will flash upon the completion. Confirm the flashing, and turn off the switch 2, 3, then reboot.	System Reservation: Always OFF
		System Reservation: Always OFF

DIP Switch 2

It is used to run SDK and start the system with SD card. Do not use this switch for other purposes.

The factory default of all switches are set to "OFF".

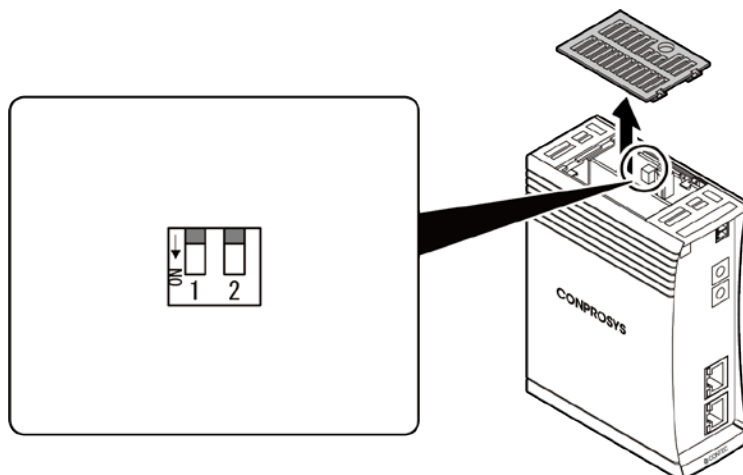

CONPROSYS WEB Setting

This chapter describes the "CONPROSYS WEB Setting" in which the functions of the product are set.

1. CONPROSYS WEB Setting Outline

The functions of the product can be set easily with the "CONPROSYS WEB Setting" through a browser. This section describes the outline of CONPROSYS WEB Setting.

1. Compatible Web Browser

CONPROSYS WEB Setting is compatible with the following browsers.

Compatible Web browser	Supported Version
Microsoft Internet Explorer	Ver. 11 or later
Google Chrome	Ver. 52 or late
Mozilla Firefox	Ver. 55 or late

* Problems may arise due to the use of incompatible browser. Be sure to use the web browser that is compatible.

2. CONPROSYS WEB Setting Operation

Click the menu item on the left side of the screen. This opens a page to set the details of the menu on the right side of the screen.

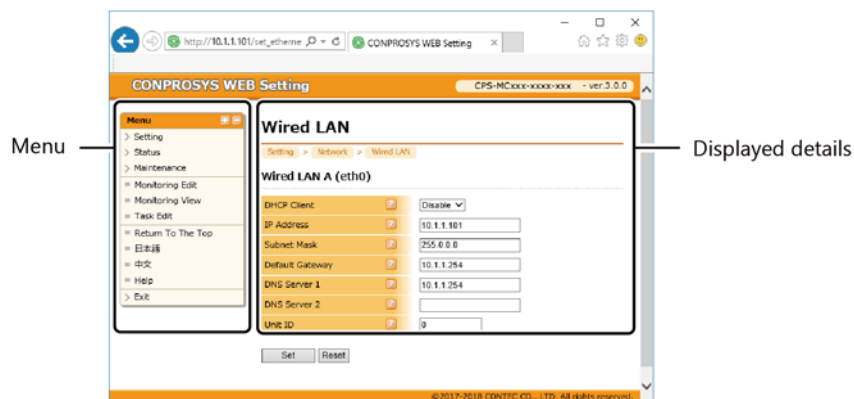

2.Menu Function List

Menu Functions are listed below.

Menu item name	Function
Setting	
Network	
Wired LAN	Set up the network such as "IP address".
Wireless LAN	Set up the wireless LAN setting such as "IP address".
3G	Set up 3G communication.
Proxy	Set up the proxy server.
Modules	Set up the modules that are installed along with the product.
Data transfer	Set up the destination of the measured data to be transferred.
Azure IoT Hub	Set up Azure IoT Hub for the device.
Time	Set up the name of NTP server that obtains the time and date.
Service	Enable or disable the specified service to be operated in the product.
Mail	Set up SMTP server to send a mail.
OPC UA	Set up OPC UA.
MT Connect	Set up MTConnect.
FTP	Set up FTP.
Status	
System	Display the product information.
Modbus Data View	Display each register value of Modbus.
File View	Display collected data.
Log	Display collected communication log.
Maintenance	
Firmware Update	Update the firmware.
Configuration File	Backup and restore the configuration file.
User/ Password	Set a user name and a password when logging in the product through a Web browser.
Network Test	Network reachability can be checked with ping command.
Monitoring Edit	Display the monitoring edit page (CONPROSYS HMI).
Monitoring View	Display the monitoring page (CONPROSYS HMI)
Task View	Display the task program edit page (CONPROSYS VTC).
Exit	
Save and Reboot	Save the settings and reboot the product.
Save and Shut down	Save the settings and shut down the product.
Save	Save the settings.

Menu item name	Function
Reboot	Reboot the product.
Shut down	Shut down the product.

*Refer to the "Reference Manual (Software)" for the details of each item.

Set the Computer Network

This chapter describes how to connect the product with a PC, set the network, and check the communication.

1.Items to Set Up

The product requires the items listed below to set up. Have the followings ready.

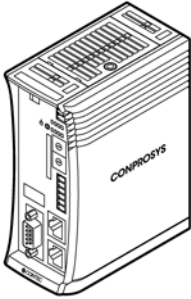

Controller
(CONPROSYS product)



Computer

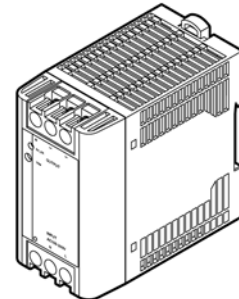

Power unit (Individually sold:
(CPS-PWD-90AW24-01 recommended)

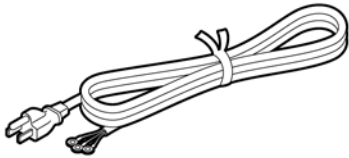

AC power cable
(Individually sold:
IPC-ACCODE3 recommended)

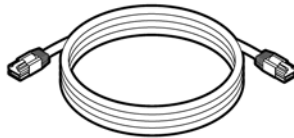

LAN cable
(Cross cable)

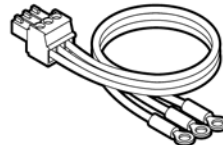

Power cable
(This comes with the above
recommended power unit)

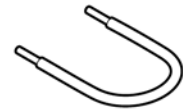

Lead
(AWG28-16
recommended)

2.Connectors for Setup

The positions of connectors to connect cables are listed below.

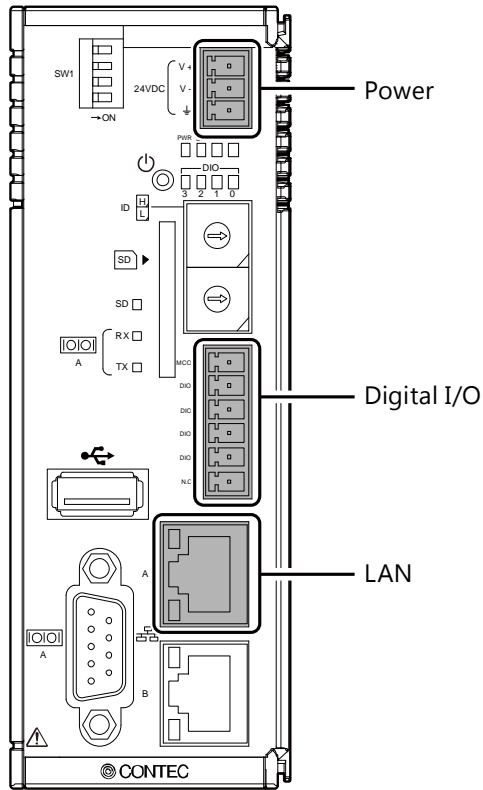

3. Connect with a PC

To set the product, you need to first set up the network between the PC and the product in order to establish communication.

First, connect the product with the PC.

- 1 Follow the instructions below to connect the computer, the controller, and the power unit.

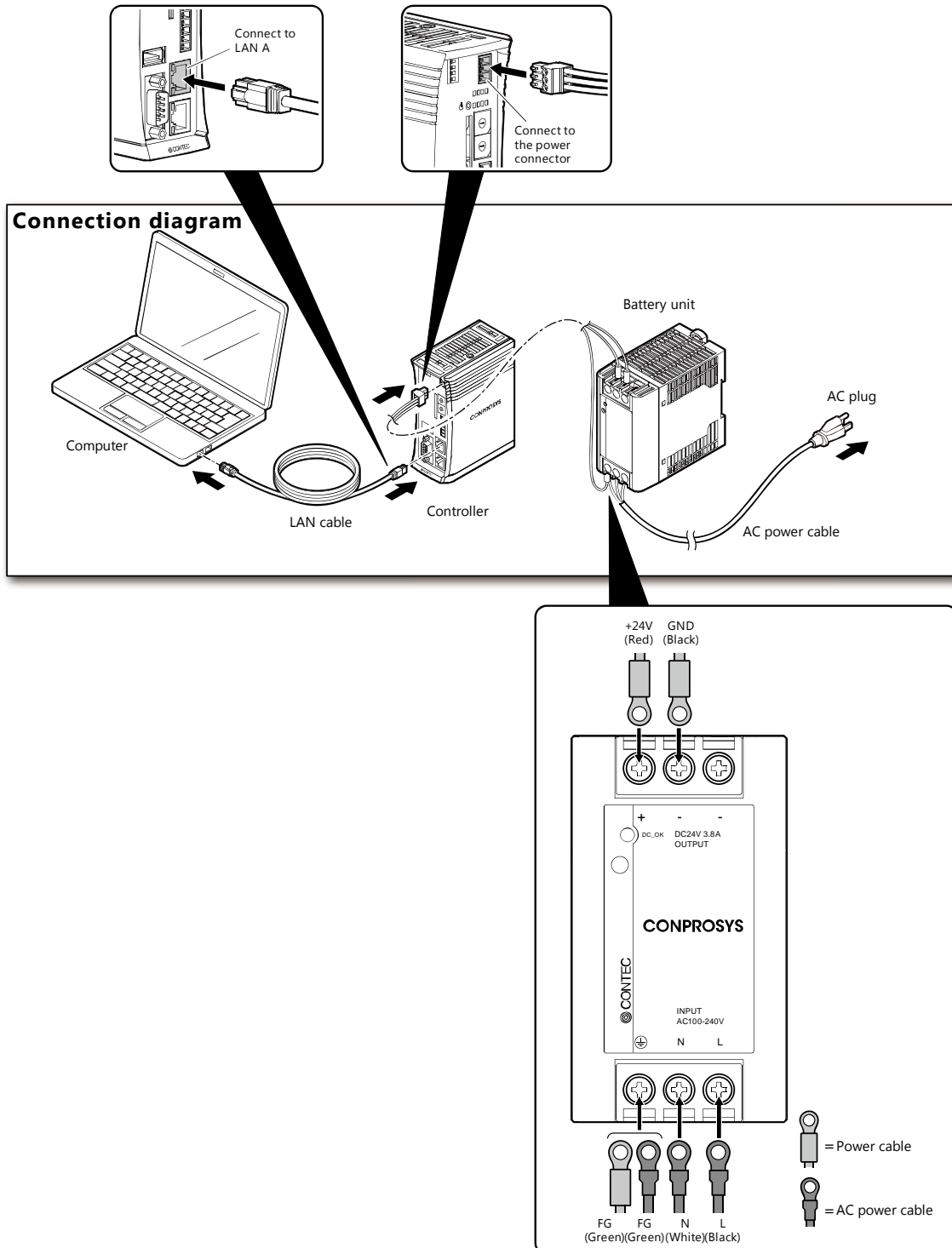

2 Connect the power unit with AC plug, then turn on the computer.

*After connecting the power unit with AC plug, it takes a few minutes for the controller to complete the start-up. (approx. 1-2 min)

4. Set the Computer Network

Follow the "Computer Network Setting Procedure" described below and set the network to make the IP addresses as shown.



Computer

IP address	10 . 1 . 1 . 200
Subnet mask	255 . 0 . 0 . 0

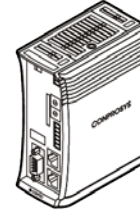

Controller

IP address	10 . 1 . 1 . 101 *
Subnet mask	255 . 0 . 0 . 0 *

* The factory default setting

The product must set a unique IP address for the bold part (**200** or **101**) that is not used by other devices on your network.

1. Computer Network Setting Procedure (for Windows 10)

Follow the procedure described below to set computer network.

- 1 Click the [Network & Internet] on [Windows Settings] screen.

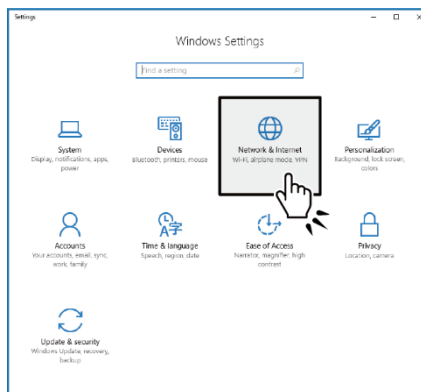

2 Click the [Change adapter options] in [Network status].

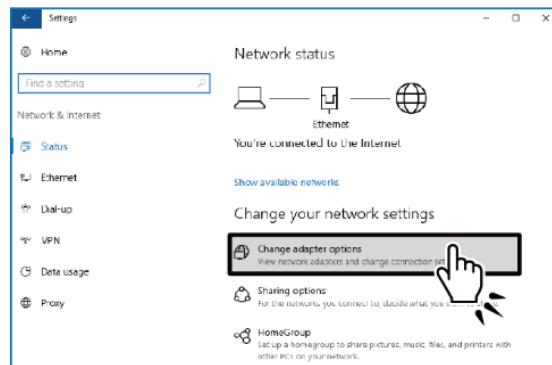

3 Double-click the appeared [Ethernet]

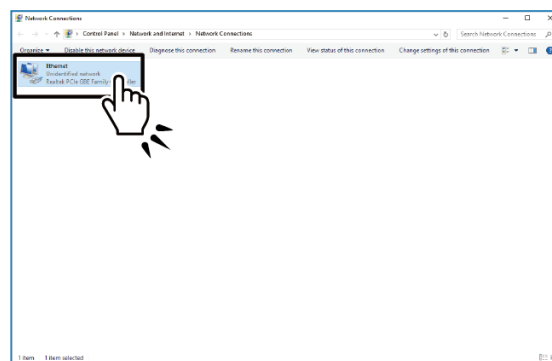

4 Click the [Property] in [Ethernet Status] dialog box.

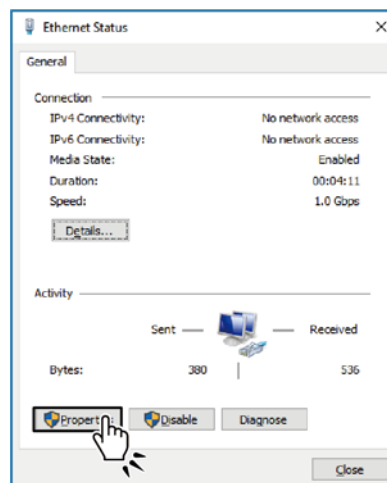

5 Double-click the [Internet protocol version 4(TCP/IPv4)] in [Ethernet Properties] dialog box.

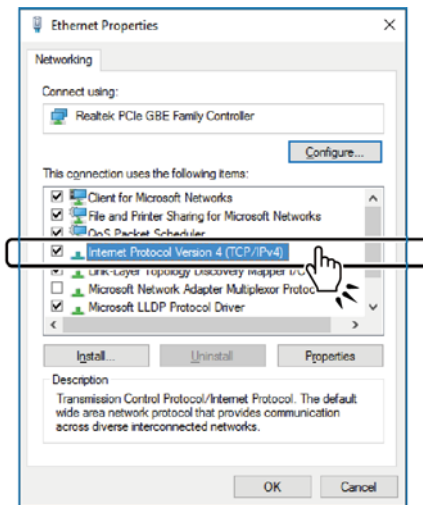

6 In the [Internet protocol version 4 (TCP/IPv4) property], set IP address and Subnet mask as shown below.

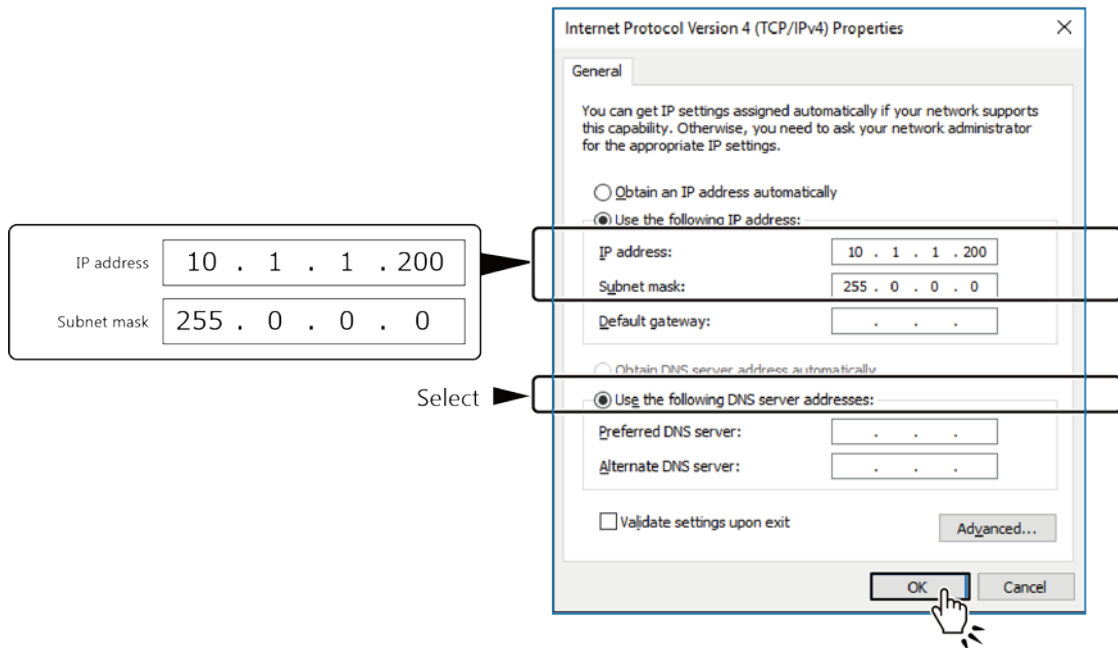

7 Click the [OK] → the [OK] → the [Close] to close the dialog box and complete the network setting.

5. Check Communication

- 1 Start Web browser on your computer. Enter IP address (10.1.1.101) of the controller in the address bar, then press the [Enter] key.
The dialog box asking for the User name and Password appears, enter them and click the [OK].

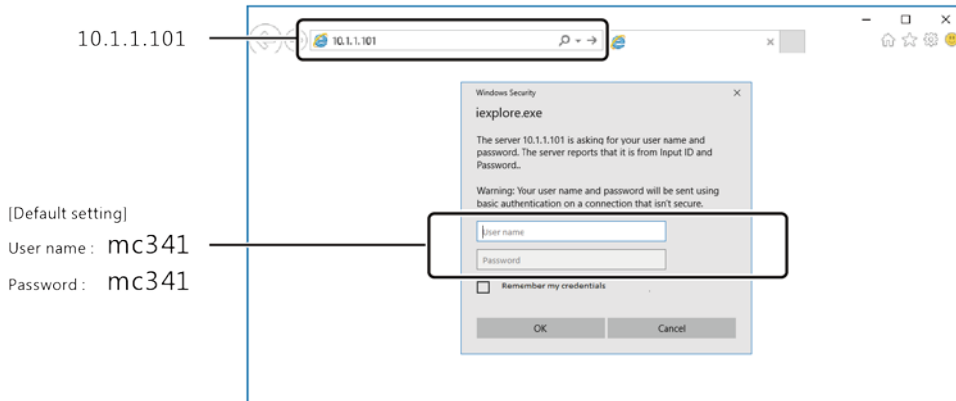

- * Refer to “**Compatible Web Browser (page 21)**” for details of compatible web browser.
- * For an actual operation, change User name and Password in [User name and Password] from the Maintenance menu.
- * After entering IP address and pressing the [Enter] key, the “Security certificate” might appear on the screen. Choose the [Continue to this website].

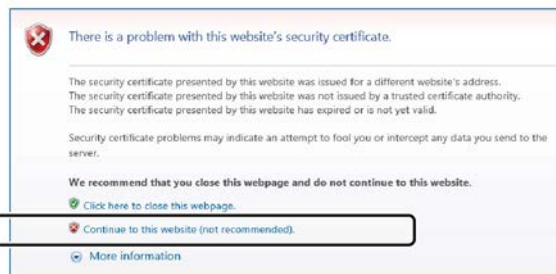

- 2 If CONPROSYS WEB Setting screen appears, it indicates the success of the communication between the computer and the controller.

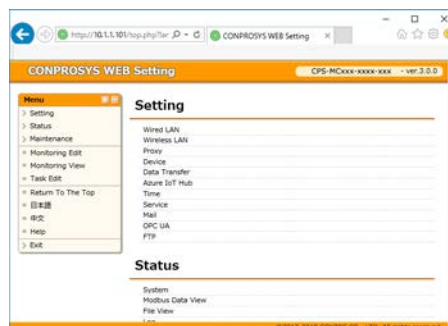

6. Check Operation

Once communication has confirmed, proceed to the next steps described below to check whether the controller is operating properly.

- 1 Connect the pin number 2 (DIO0) and 3 (DIO1) of the digital I/O connector with the lead-wire to create the connector for operation check.

* The leads are not included in the package. Please use the recommended lead, AWG28-16.

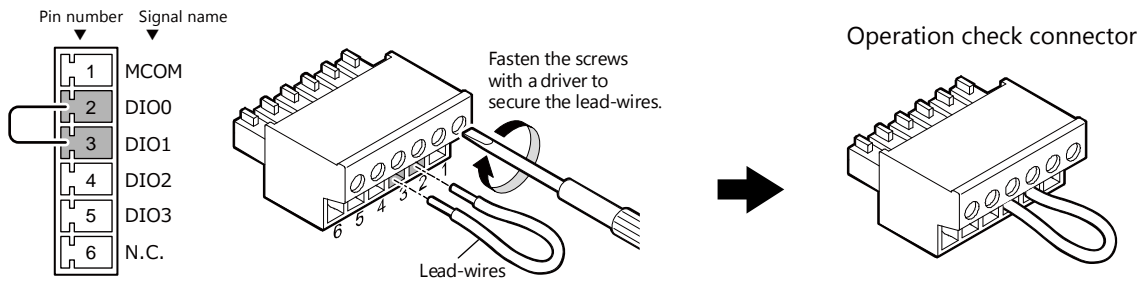

- 2 Place the operation check connector into the digital I/O connector of the controller.

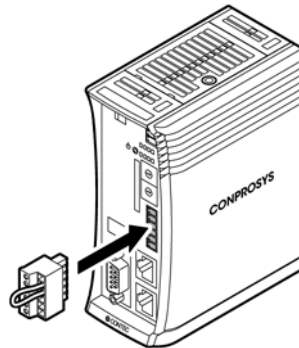

- 3 On your computer, start up Web browser and enter IP address (10.1.1.101) of the controller in the address bar, then press the [Enter].

The screen asking your user name and password appear. Enter them in the dialog box and click the [OK] to show CONPROSYS WEB Setting.

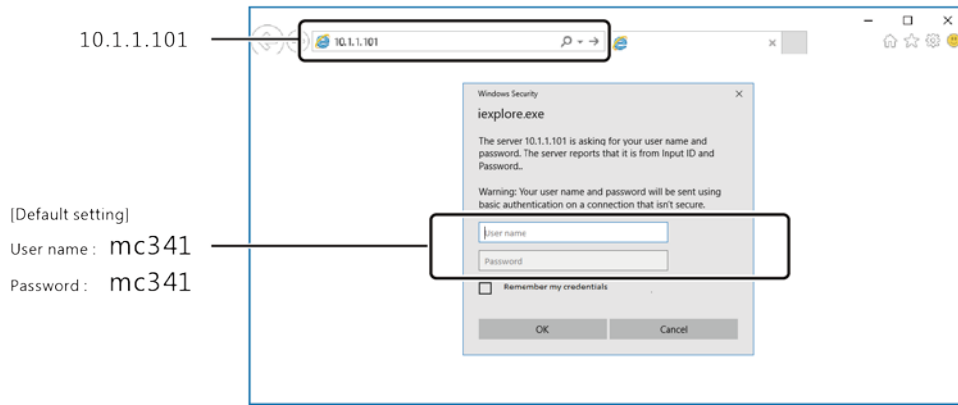

4 From CONPROSYS WEB Setting, click the [Monitoring edit] to show the "CONPROSYS VTC".

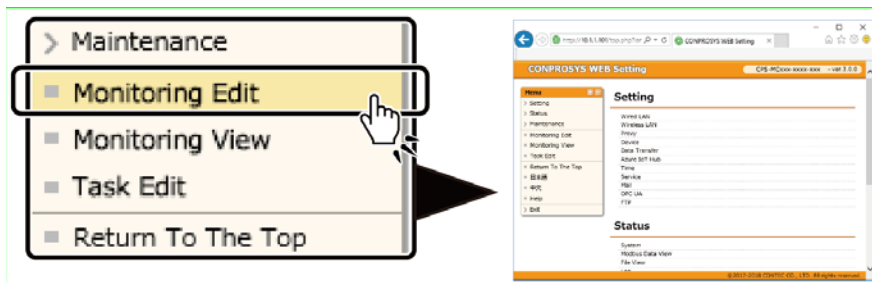

For the details of CONPROSYS VTC, refer to the "Easy Data Process and Control" or the "Reference Manual (Software)".

5 Click the module images or the [Configure] button in the list to set the details.

- Module images

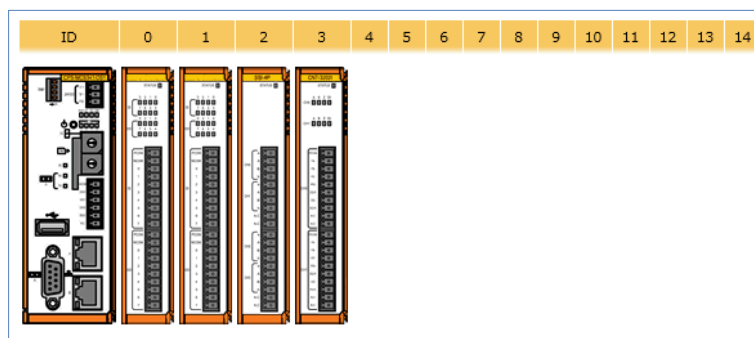

- Module list

ID	Category	Name	I/O channels	Configure
-	CPU module	CPS-MCS341-DS1	COM: /dev/com00	Configure
0	Digital I/O	CPS-DO-16L	Output: 16bit	
1	Digital I/O	CPS-DI-16L	Input: 16bit	Configure
2	Temperature sensor	CPS-SSI-4P	Input: 4ch	Configure
3	Counter	CPS-CNT-3202I	Input: 2ch	Configure

6 Change those DIO0, DIO1 to value DIO0⇒DI, DIO1⇒D 1O respectively.
(Default settings are all DI)
Click the [Set] after setting

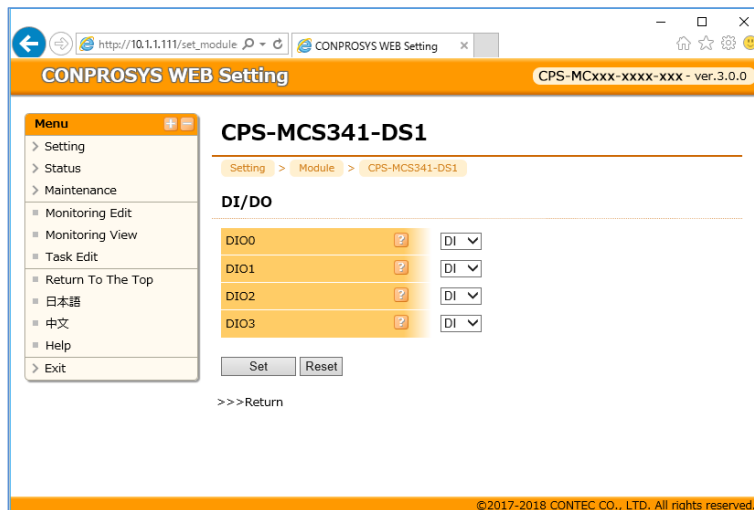

7 After changing the settings, go to [Exit] on CONPROSYS WEB Setting, and click the [Save and Reboot] to save the changes and reboot the controller.
*PWR LED will be on once the changes are saved (saving time: approx. 20 seconds).
*It takes about one minute to reboot the controller.

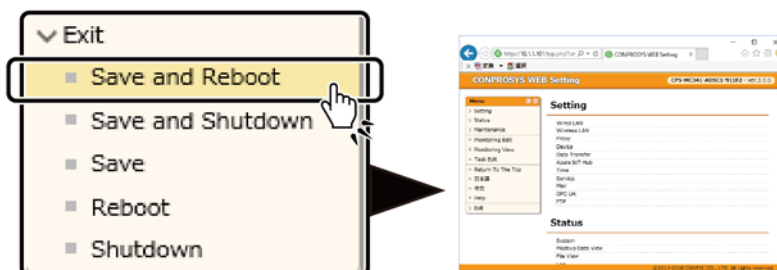

- Click the [Monitoring edit] on CONPROSYS WEB Setting, and change to the "Run" in the Mode that is located on the upper-right side.
From here, create a monitoring view screen with "CONPROSYS HMI".

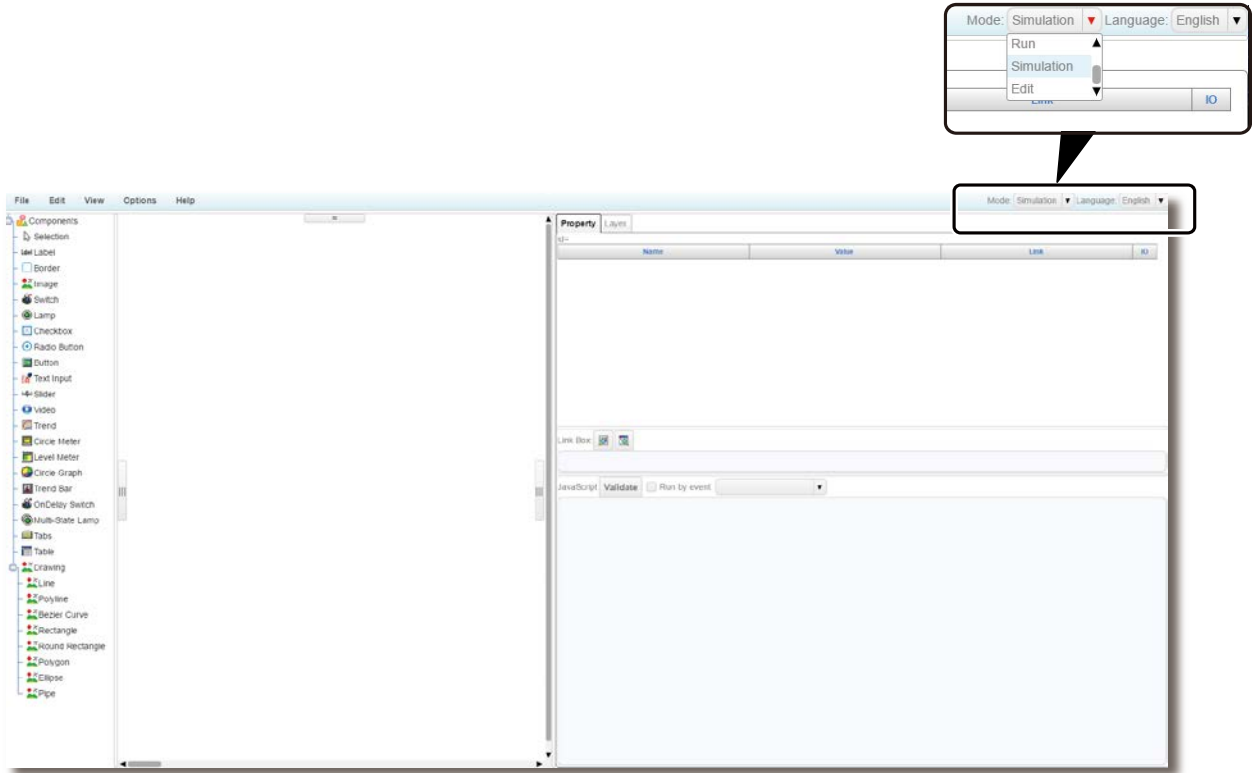

Refer to the "[Monitoring edit]" or the "Reference Manual (Software)" for CONPROSYS HMI details.

- 9** From Components list on the left side, select “Switch” and “Lamp” controls and drag & drop them onto the “Layer area”.

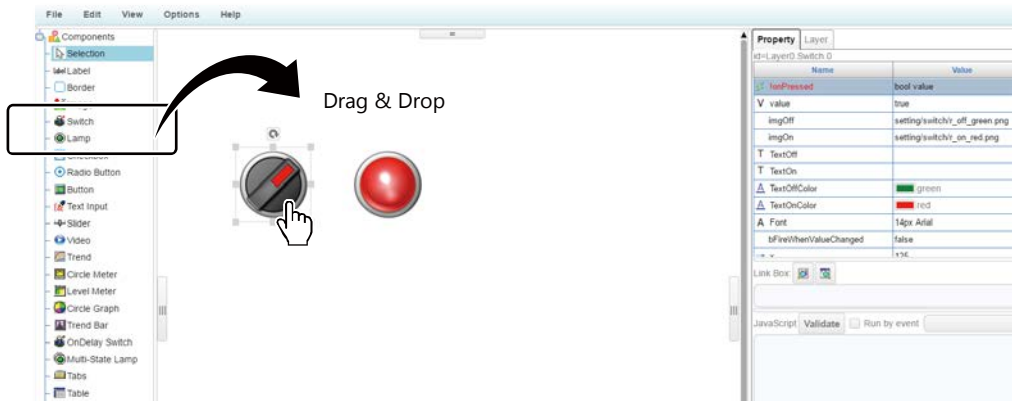

- 10** Set the switch.

- (1) Click the “Switch” control on the layer area to activate.
- (2) Click [! OnPressd] in the [Property tab] on the right side, (3) and click “Link Box” icon in the Link Box.
- (4) Select [CPU_DO01] in Device Tree and click (5) the [OK].
This connects the Switch and the connector [DIO1].

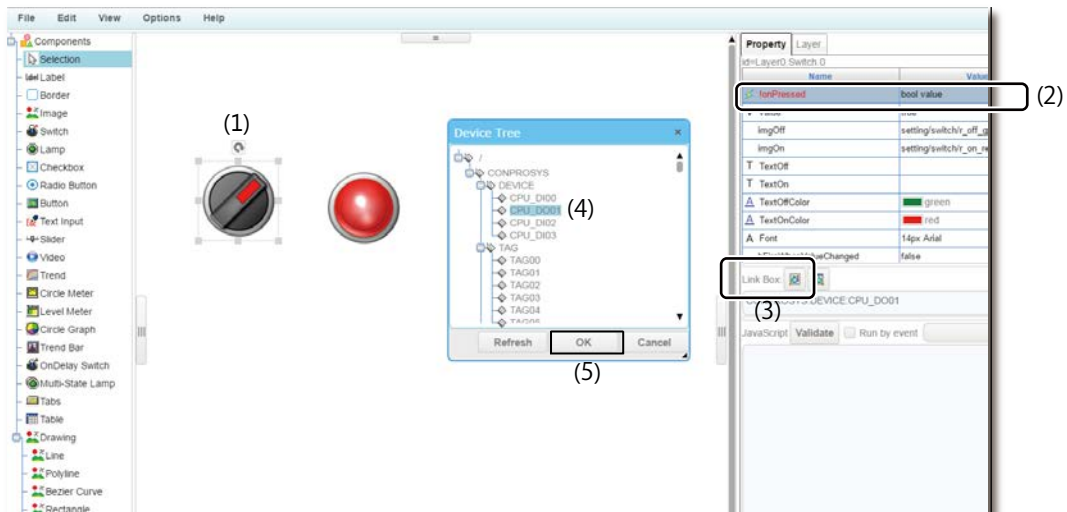

11 Set the lamp.

- (1) Click the “Lamp” control on the layer area to activate.
- (2) Click [value] in the [Property tab] on the right side, (3) and click “Link Box” icon in the Link Box.
- (4) Select [CPU_DI00] in Device Tree and click (5) the [OK].

This connects the Lamp and the connector [DIO0].

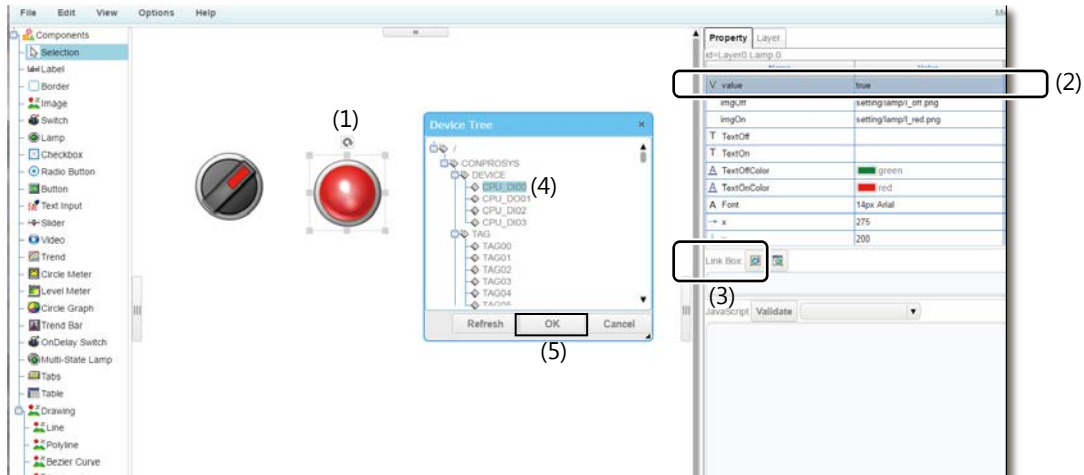

12 Clicking the Switch on the Layer area turns the Lamp on/off.

At the same time, it turns on and off the LED on controller together.

This confirms that the controller is operating properly.

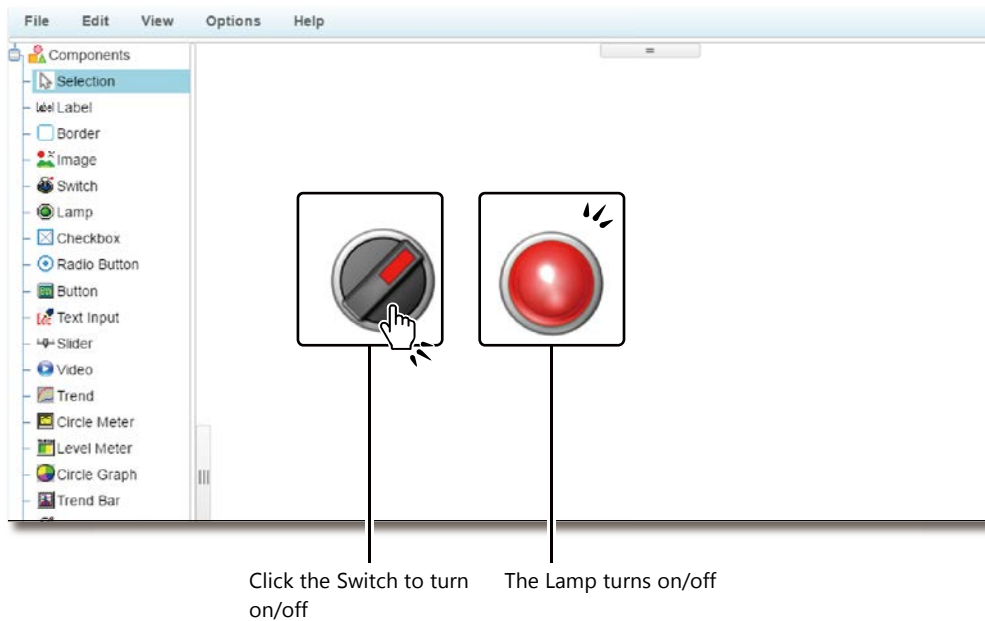

Installation

This chapter describes installation conditions and how to mount the product on a DIN rail.

1. Install the Product

1. Installation Conditions

◆ Installation Orientation

Install the product in the orientations shown below (0 °).

Other orientations may cause problems such as malfunctions due to inadequate heat dissipation.

DIN rail Mounting

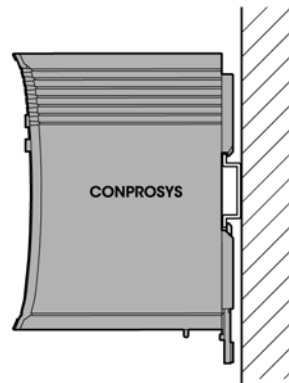
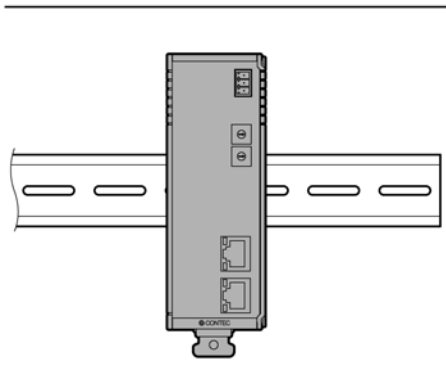

◆ Ambient Temperature

The ambient temperature is decided from the multiple measurement points which are a 50mm-distance from the product.

During the operation, adjust the air current to make certain that the temperatures measured in the points stay within the specified temperature. (-20 - +60°C)

*If you use the USB device with bus power, the ambient temperature should be -20 - +55°C.

Configurable controller alone

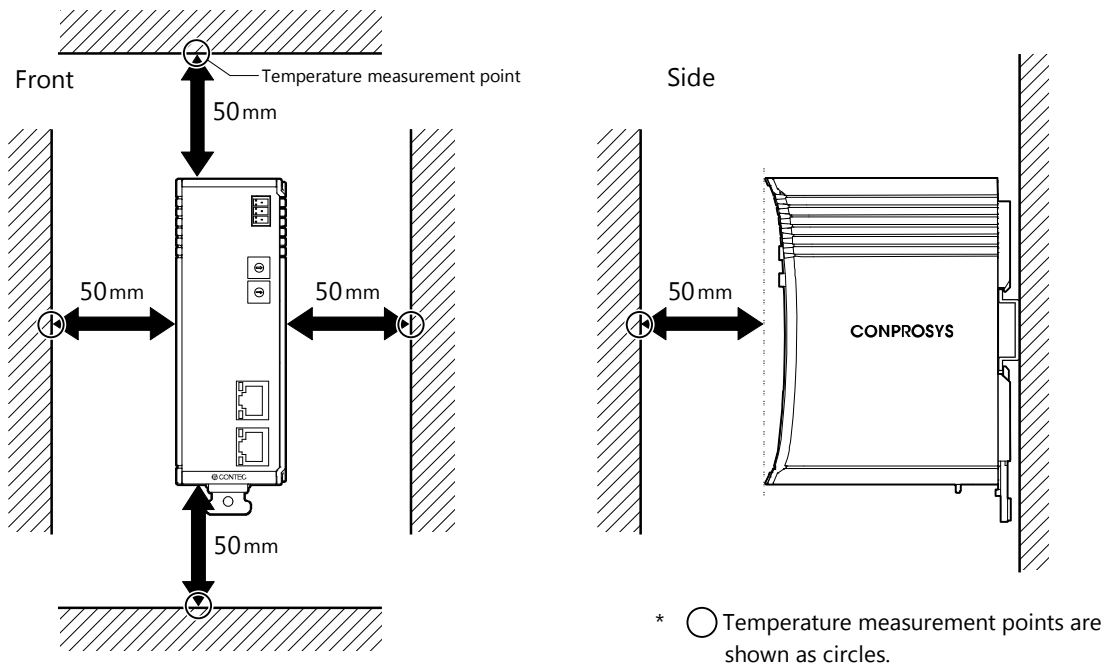

Configurable controller and module(s)

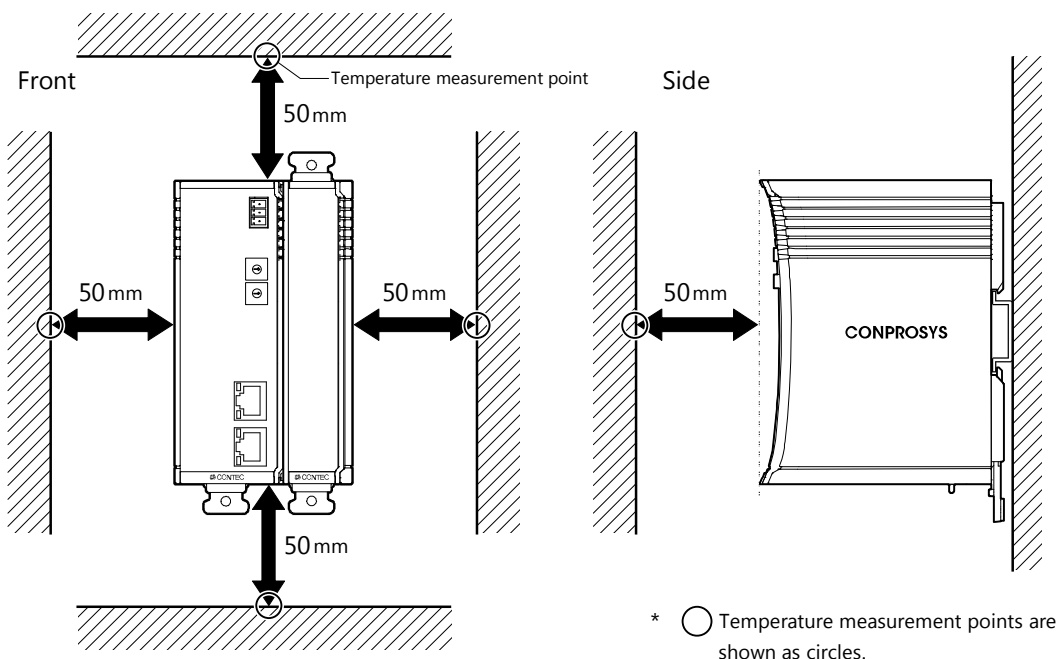

CAUTION

- Note that although the ambient temperature is within the specified range, an operational malfunction may occur if there is other device generating high heat; the radiation will influence the product to increase its temperature.
 - Do not install this product into the fully-sealed space except the case in which the internal temperature is adjustable by equipment such as air conditioner. Long-term usage might increase the temperature of the product and lead to malfunctions or other troubles.
 - When using the product in a high temperature environment, its life time will be shorten. Perform the forced air cooling to counteract.
-

◆ Installation Place

Improper installation place could cause communication failures or quality deterioration. Follow the instructions listed below.

- Do not place the product too close to the metal or concrete walls (including steel-frame).
- Do not leave any metal pieces around the antenna.
- Do not install the product outside of the communication area of the carrier.

When communication failures or quality deterioration occurs, use the antenna listed in the optional product.

2. Mounting on a DIN Rail

This product should be set on DIN rail for operation.

◆ How to Mount

- 1** Pull down the hook to unlock.
If the hook is stuck, use a slotted screwdriver to unlock.

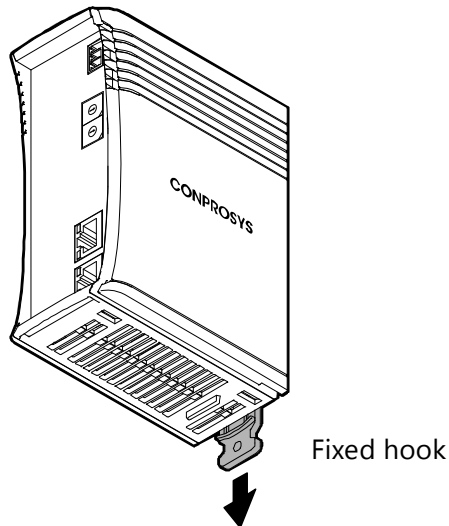

- 2** (1). Hang the product on the upper part of the DIN rail.
(2). Press it to the lower side of the DIN rail.

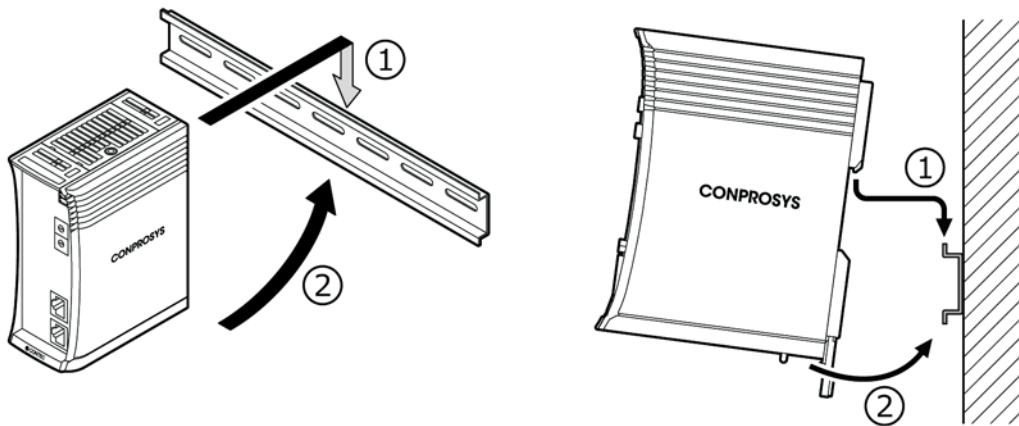

- 3 Push the hook up to lock the product on the DIN rail.

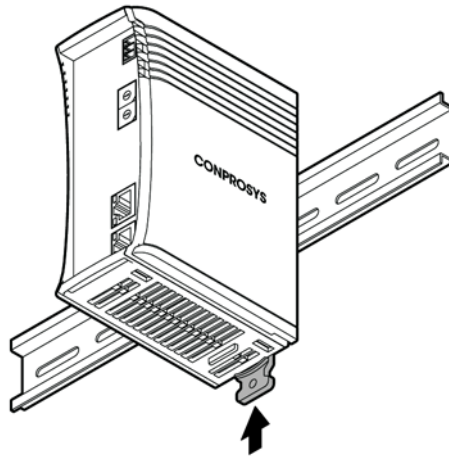

*When removing the controller, reverse the procedure described in "**How to Mount (page 43)**".

3. Setting the Configurable Type Module

⚠ CAUTION

- Always confirm the PWR-LED is turned off before setting or removing the modules

◆ How to Set

- 1 First, slide the attached end cover to remove it from the product that is mounted on the DIN Rail.

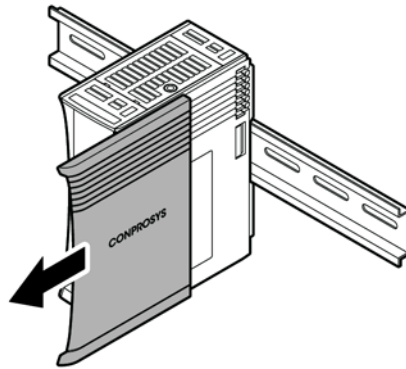

- 2 Unlock the hooks of the module.
If the hooks are stuck, use a slotted screwdriver to unlock.

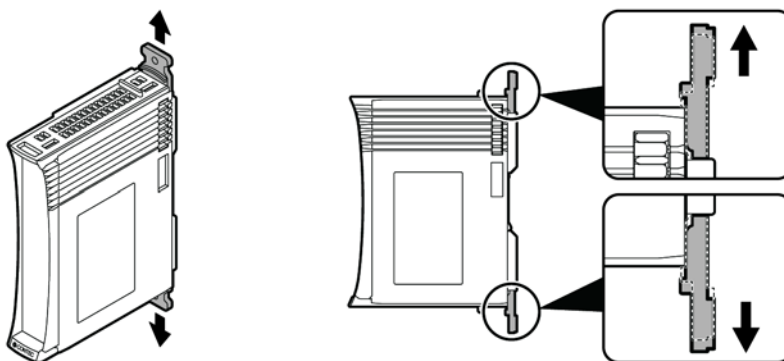

- 3** Engage the side rail of the setting module to the side rail of the controller (or another module) that is already mounted.
When the rails fit, slide the setting module all the way toward the DIN rail.

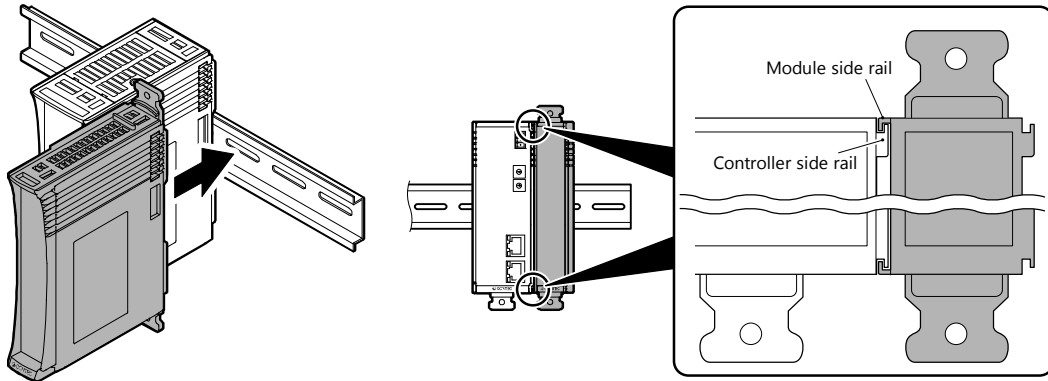

- 4** Fix and secure the module on the DIN rail by locking the hooks.

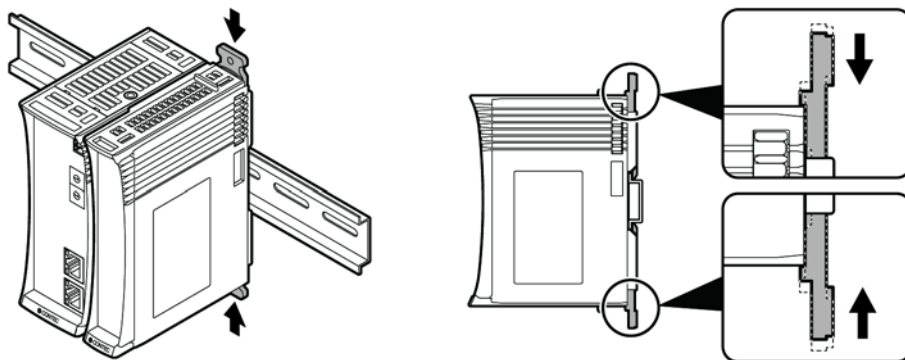

- 5** Put back and slide the end cover to the module.

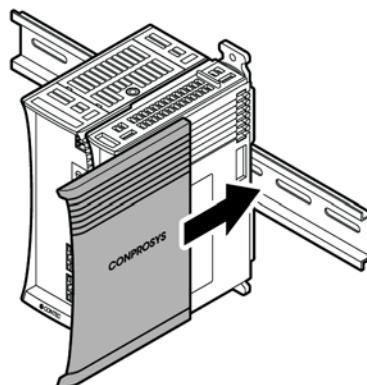

*When removing the module, reverse the procedure described in "**How to Mount (page 43)**".

Connecting with CODESYS

This chapter describes how to use the product with CODESYS.

Reading the following instruction when using the "PAC series" controller.

1. Using CODESYS

With PAC series, you can utilize the "CODESYS", a device-independent system that is compliant with the IEC 61131-3 standard, for PLC or HMI development.

To use the CODESYS, installation of the CODESYS development environment and "CODESYS Package" for CONPROSYS are required.

1. How to obtain the CODESYS development environment

CODESYS development environment can be downloaded from the CODESYS website.

- 1 Through Web browser, access to the CODESYS Store. Click (1) the [Download] button. The CODESYS is consistently upgraded. Make certain to choose the latest version.

Download

<http://store.codesys.com/codesys.html>

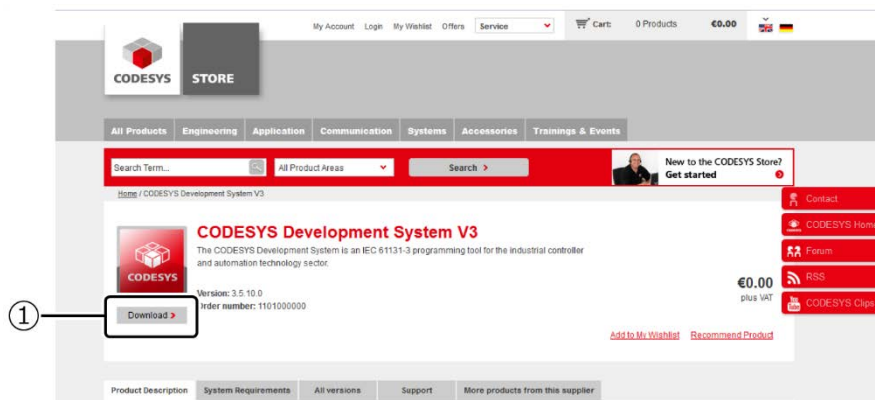

- 2 "Login or Create an Account" page appears after clicking the [Download] button. If you are a registered customer, enter your email address in (2) "Email Address", and password in (3) "Password", then click (4) the [Login] button. If you are a new user, register through (5) "New Customers" to log in.

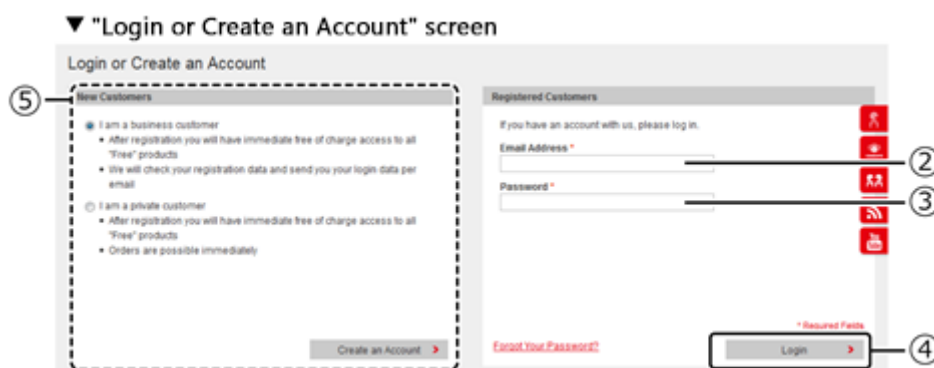

- 3** After log-in, click the "Download" to start downloading.
- 4** Execute the downloaded file and install CODESYS development environment into the host computer.

2. Installation of CODESYS Package

Install the CODESYS Package from the CONTEC website.

- 1 Go to the CONTEC website. From the menu Downloads, select [Drivers & Software]. Enter the product name or specify the category (PAC system) and click the [Search]. Select and click the product driver.

Download

<https://www.contec.com/>

- 2 Download the CONPROSYS Package. Run the CODESYS and select [Tools] - [Package Manager...] from CODESYS menu.
- 3 Click the (1) [Install...], and specify the downloaded CODESYS package file.
File name: CONTEC CONPROSYS PAC Series package

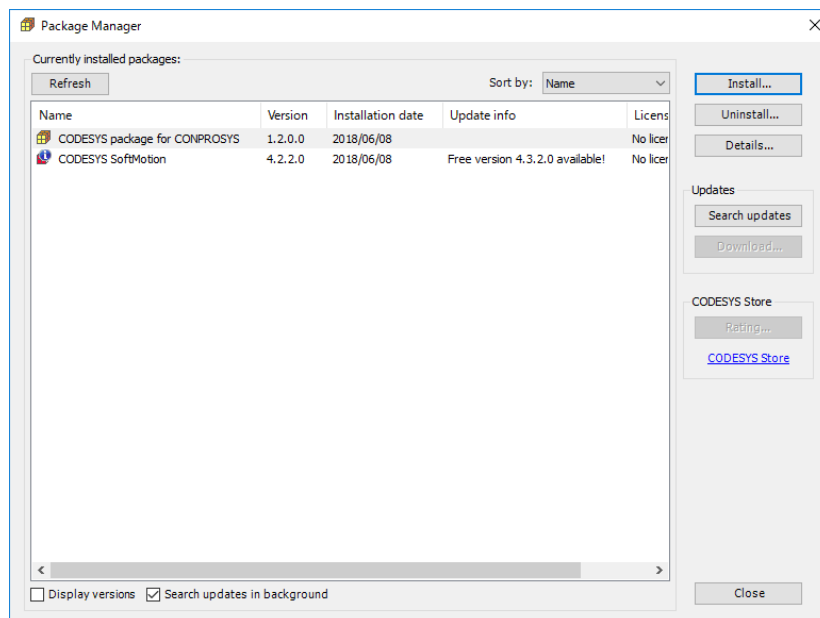

3. Connecting to pre-installed system (PLC controller)

- 1 Start up CODESYS and select [File] - [New project] on the menu.
- 2 In the New Project dialog, select (1) [Projects] from the Categories and (2) [Standard project] from the Templates. Specify the (3) Name and the (4) Location of the project, then click the (5) [OK].

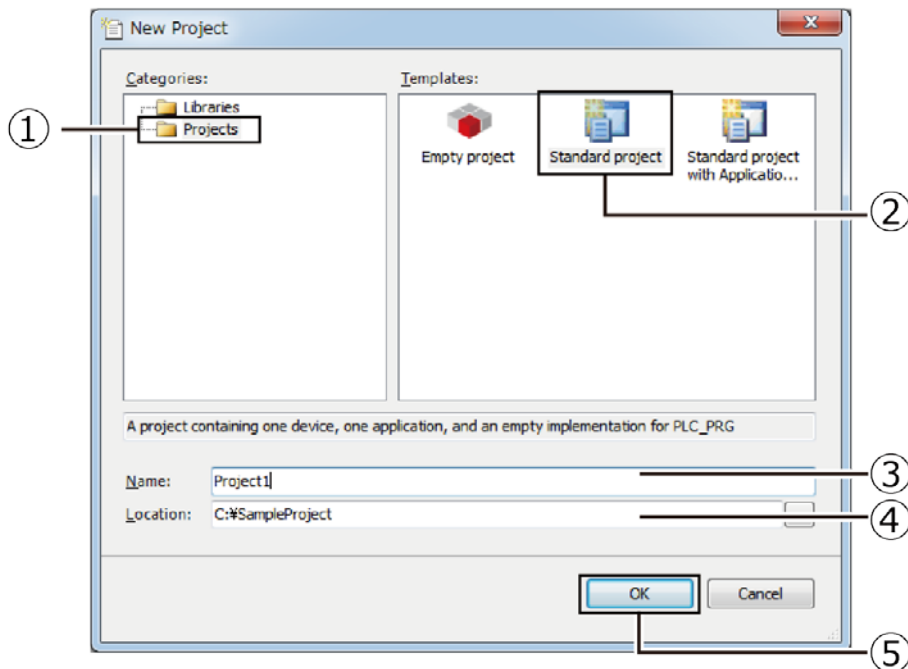

- 3 In the Standard Project dialog, select the controller to be used in the (6) [Device]. Device can be shown as [CODESYS Control CONTEC CPS-PCXXXXXXX]. From the (7) "PLC_PRG", choose Structured Text (ST).

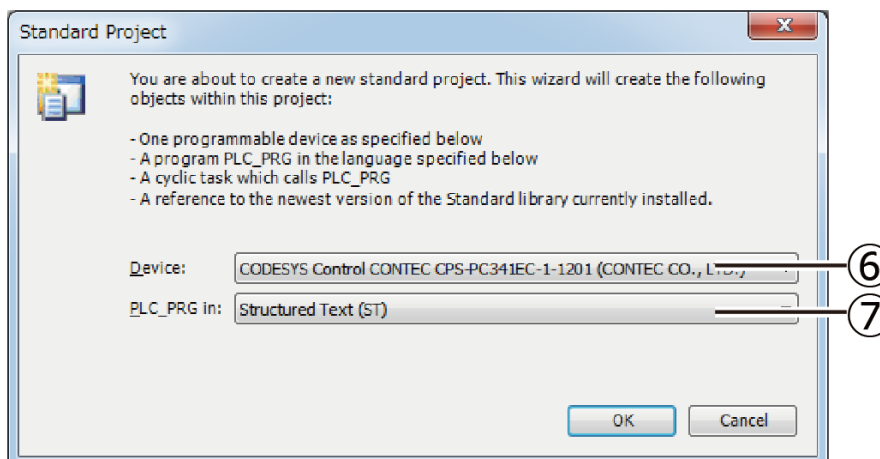

- 4** Now, see whether connecting the controller from CODESYS can be achieved.
- 5** On the Devices window, double click the (8) "Device (CODESYS Control CONTEC CPS-PCXXXXXXXXXX)" icon to open "Device Configuration window". Select the (9) [Communication Settings] in the Device tab.
- 6** Enter "10.1.1.101" into the (10) "Combo-box", then press [Enter] key on your keyboard. If the color of the circle changes to green, it indicates the connection to the controller has been established.

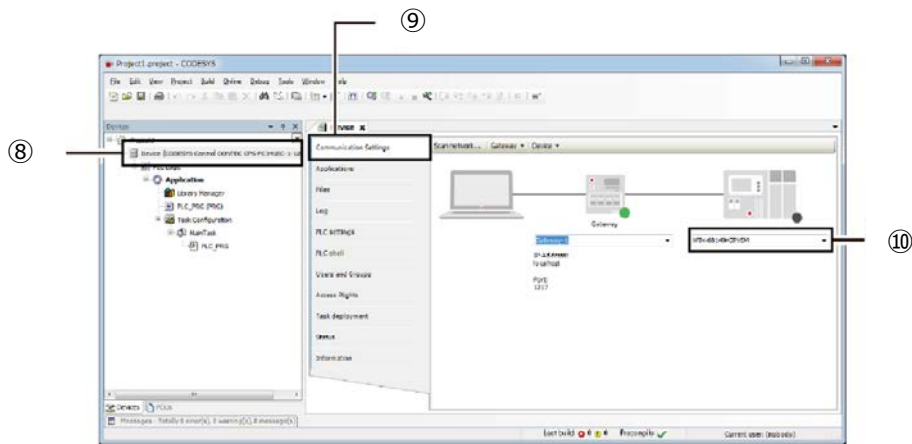

7 Add (Connect) I/O modules.

- (1) Right-click on the controller of CODESYS device window and select (2) the [Add device].
- (3) In the dialog box, select and double click the I/O module you wish to add. I/O module is located under the tree hierarchy of [Others].

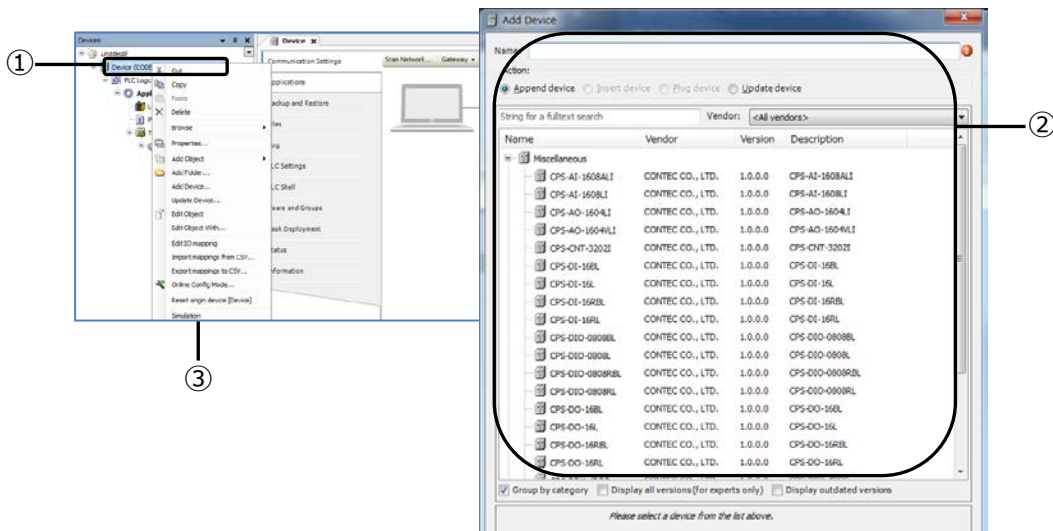

Refer to the "Reference Manual (Software)" for I/O assignments and PLC program.

Appendix

This chapter describes how to use the task function "CONPROSYS VTC" and the monitoring function "CONPROSYS HMI" that are implemented in the product.

1. Useful functions

The M2M controller features the "CONPROSYS VTC"(Visual Task Control), with which you can create processing tasks without language programming by combining icons like drawing the flowchart to calculate or control data, and the "CONPROSYS HMI"(Human Machine Interface), which monitors the input signals and displays the conditions of the signals with control icons.

1. Task processing function (CONPROSYS VTC)

With the CONPROSYS VTC (Visual Task Control), adding signal processing can be done easily through a web browser. Programming can be done with a script language by simply placing and setting control icons through a web browser.

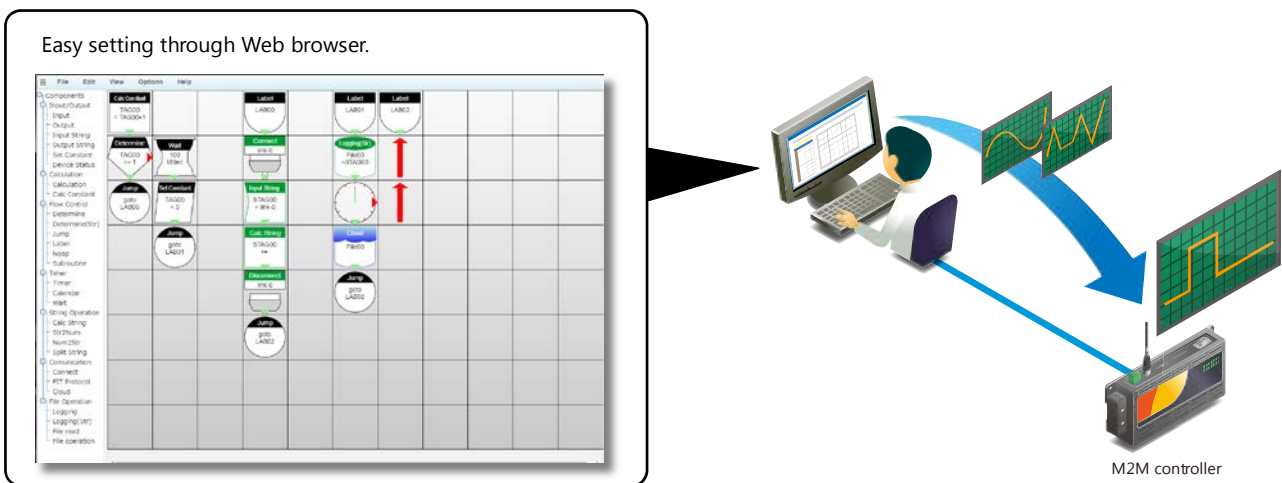

2. Work Area

CONPROSYS VTC has the following work areas.

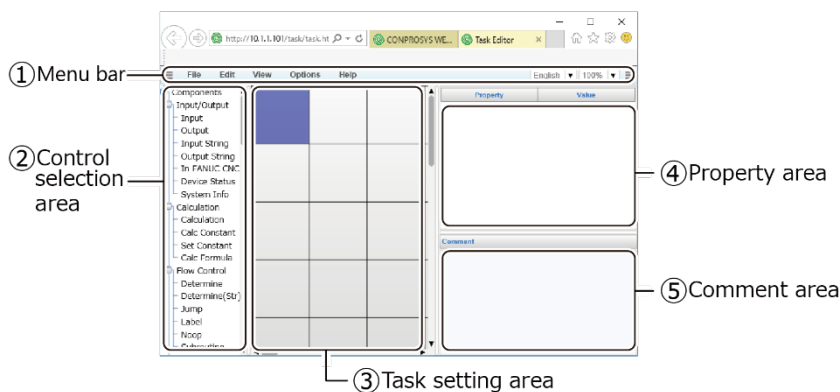

No.	Name	Function
1	Menu bar	The menu bar is used to execute commands with menu buttons.
2	Control selection area	The task controls can be selected to place on the task setting area.
3	Task setting area	This area is where the task controls are placed and set.
4	Property area	You can modify the property variables of controls with this area.
5	Comment area	This area can be used to add comments to the task controls.

3. Create Processing Tasks

From CONPROSYS WEB Setting, click the [Task Edit].

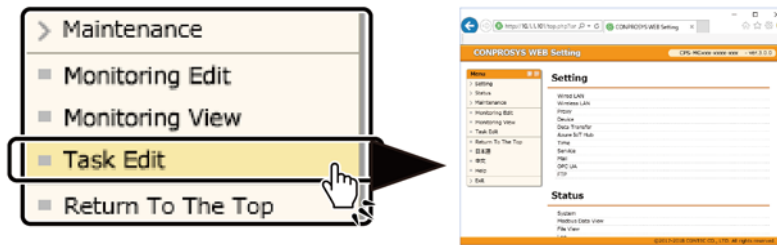

CONPROSYS VTC starts up to create a processing task.

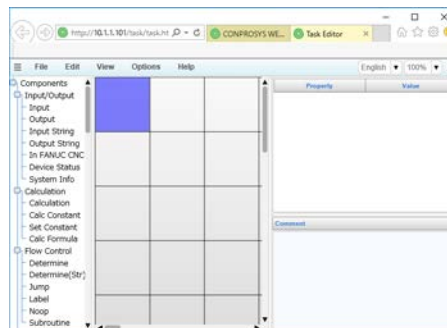

4. Basic Procedure for Creating Processing Tasks

◆ Place Task Controls

1. Select a necessary task control from Control selection area.
2. Drag and drop it onto the task setting area.

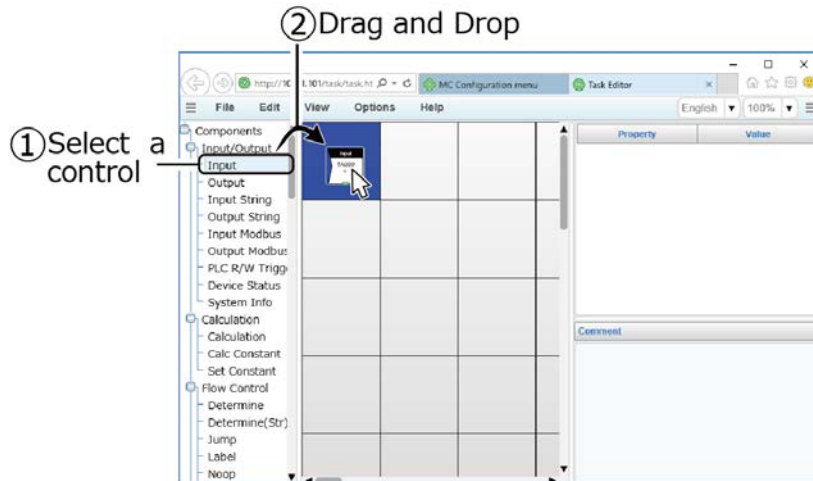

◆ Set Property

The property of placed controls are displayed on the property area.

Each control contains the parameter that represents a specific function and decides the direction (Next step) to execute the next task.

Tasks are executed from the upper left cell on a grid (X: 0, Y: 0). The next step to execute is determined by the direction set in the control.

If the next step is located outside of the page, the first task (0, 0) is proceeded.

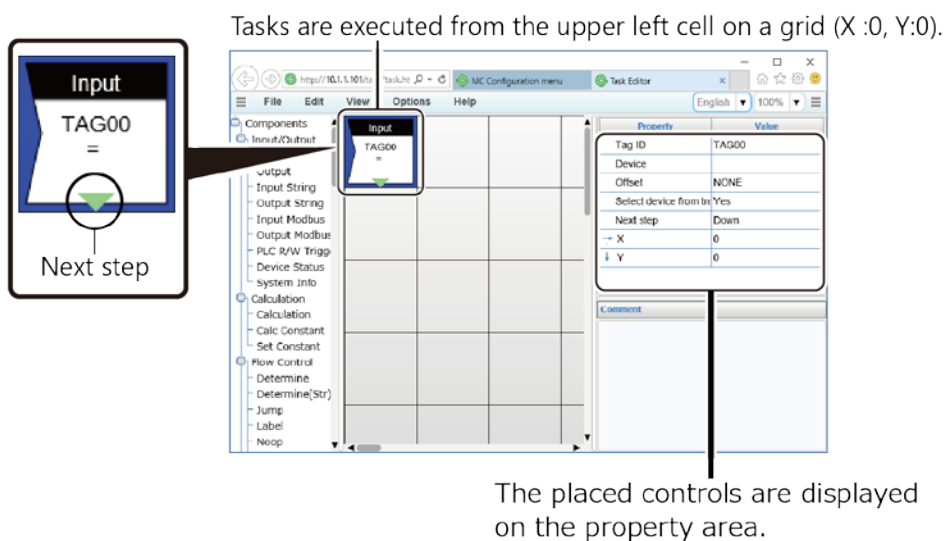

* In this example, the processing is given to the following control after reading the data that is obtained from a device to TAG00.

◆ Copy and Delete Controls

Right-click the placed control to show the editing menu. In this menu, such as copying or deleting controls can be performed.

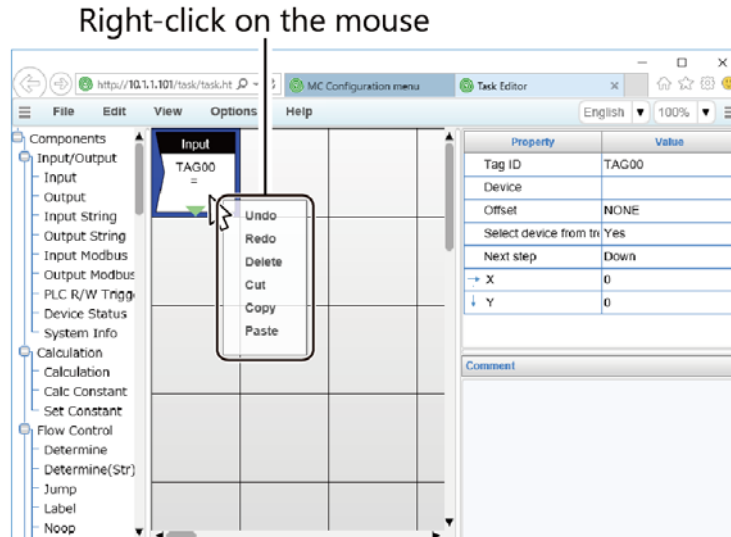

◆ Move Controls

The placed control can be moved by drag and drop.

Create the tasks by following the procedure described above to place controls on the task setting area.

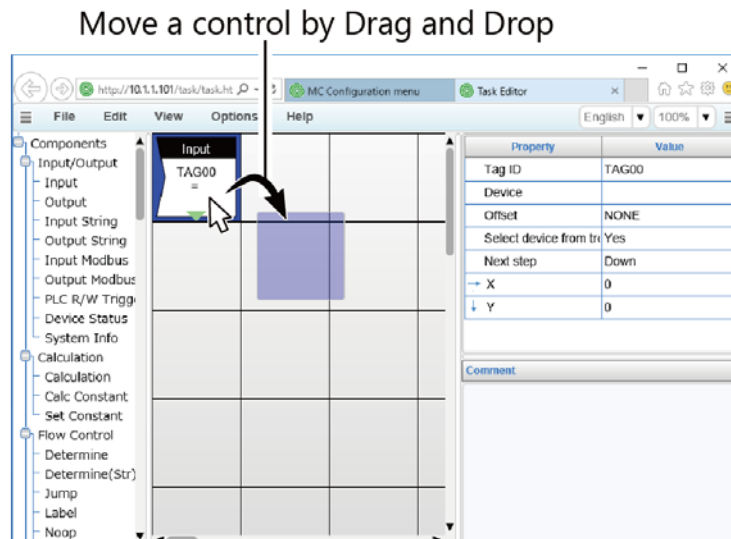

◆ Save a Task Processing

From Menu command, select the "File" – "Save task" to open a dialog to save the created task processing with the specified number.

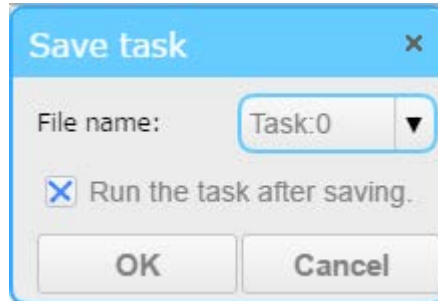

◆ Open a Saved Task

From Menu command, select the "File" – "Open task" to open a dialog and select the number in the dialog to open a saved task.

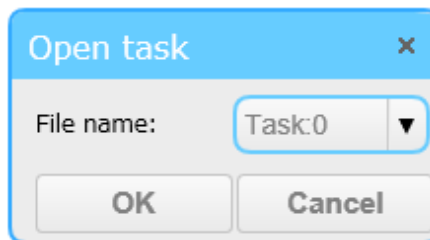

◆ Run a Task Processing

From Menu, go to "View" – "Status" and "Run" to apply the changes and run the task.

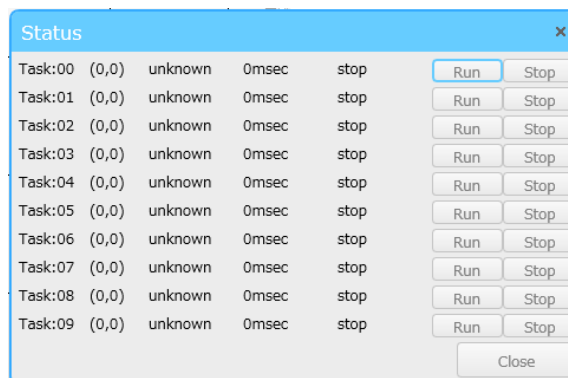

- You can create executing tasks up to 10 that work simultaneously.
- Similarly, you can create up to ten subroutines which can be called from the tasks.

Refer to "Online help" for detailed CONPROSYS VTC operations and functions.

Online Help

<http://data.conprosys.com/help/task/V1/en/>

2. Monitoring Edit

1. Monitoring function (CONPROSYS HMI)

You can create a monitoring screen through a web browser without a specialized knowledge of language programming.

Remote-monitoring of the operations, errors, or standstill in the facilities are achieved.

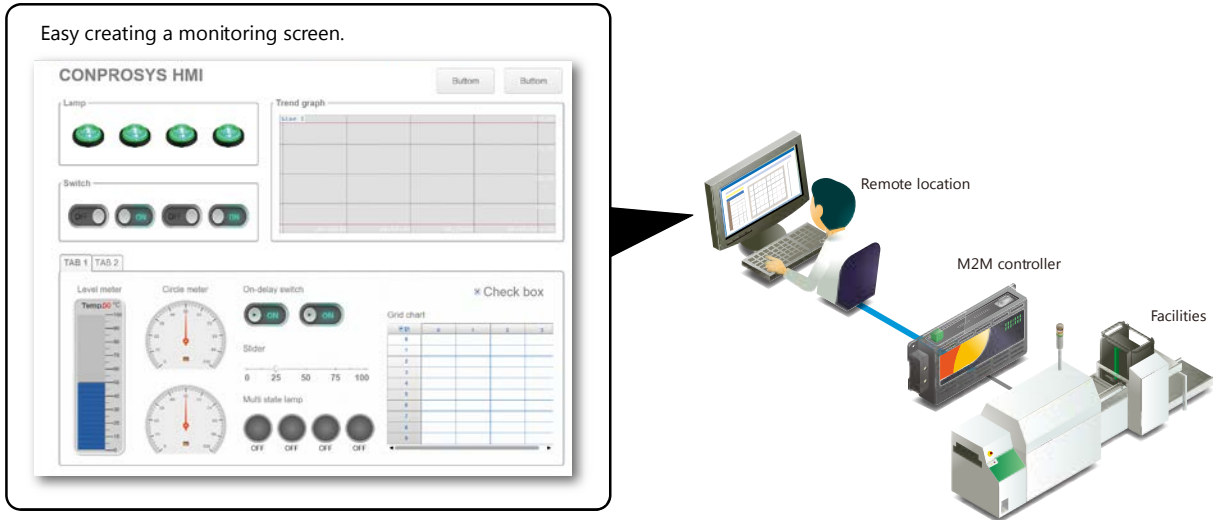

2. Work Areas

HMI Editor has the following work areas.

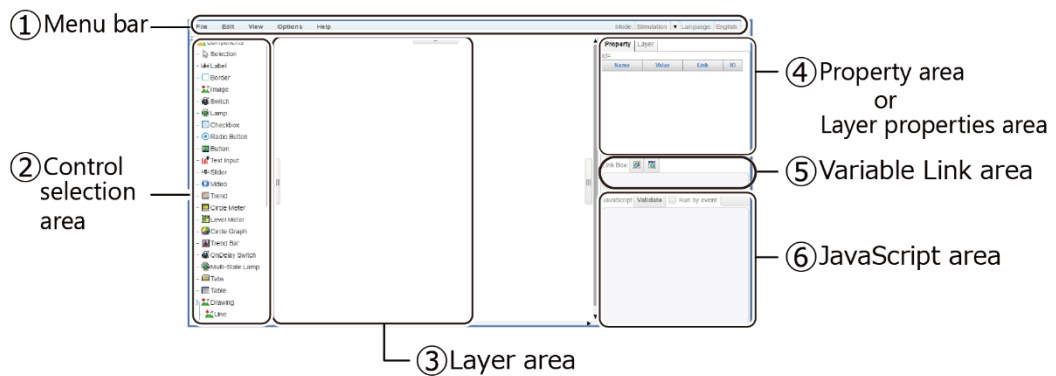

No.	Name	Function
1	Menu bar	The menu bar is used to execute commands with menu buttons.
2	Control selection area	Select the controls to place on the layer area.
3	Layer area	This area is where the page is designed.
4	Properties area	Modify the property variables of controls on this area.
	Layer properties area	Add or delete layers, and modify layer properties on this area.
5	Variable Link area	This area is for linking control properties and variables.
6	JavaScript area	This area is used to configure the behavior of JavaScript for controls.

3. Create a Monitoring Screen

From the CONPROSYS WEB Setting, click the [Monitoring edit].

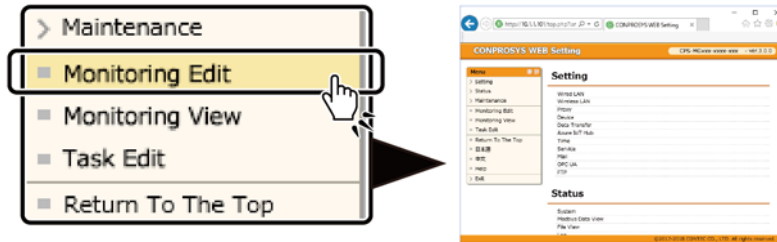

CONPROSYS HMI starts up and you can create the monitoring screen.

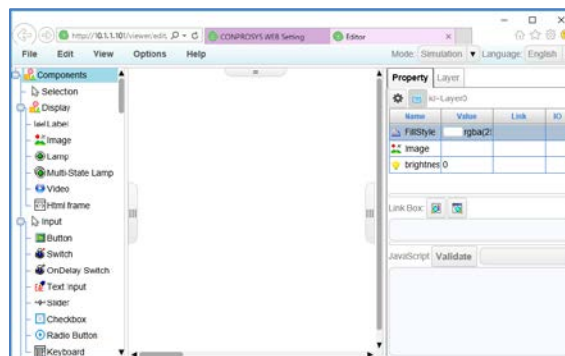

4. Basic Procedure for Creating a Monitoring Screen

◆ Place a Control

(1) Select a control from the Components tree displayed on the left. (2) Drag and drop it on the Layer area.

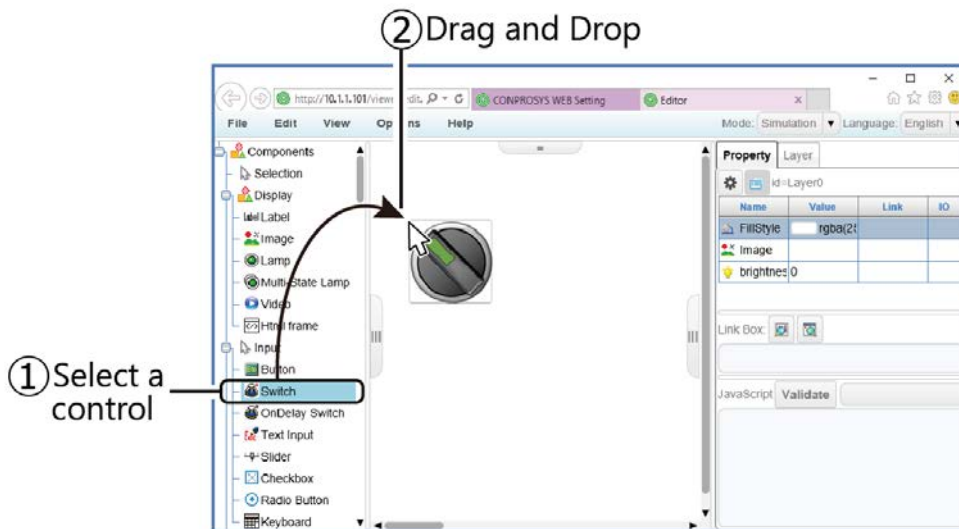

◆ Configure the Properties of Controls

(1)Click the placed control. (2)The property of the control is shown in the "Property" on the right side of the screen.

The properties area allows you to change the values, set the data to link with I/O devices or other controls.

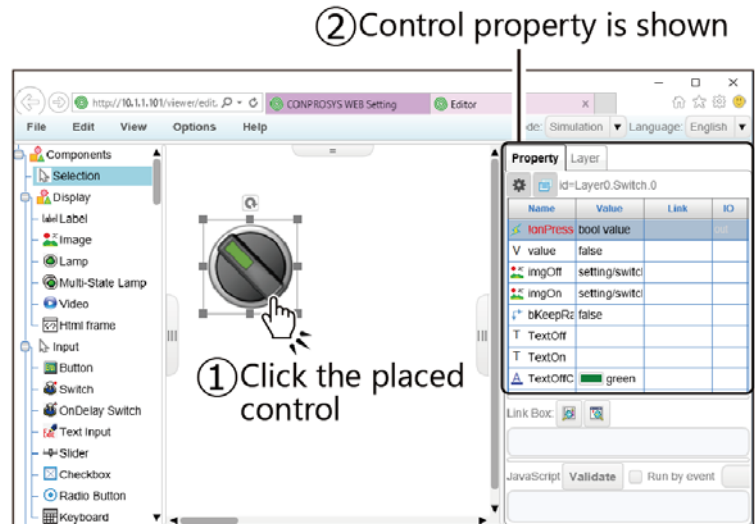

◆ Align the Position or Adjust the Size of Controls

Click the placed control to activate. Drag the border to change the position, adjust the size or the angle.

Controls can be selected together and changed or adjusted simultaneously.

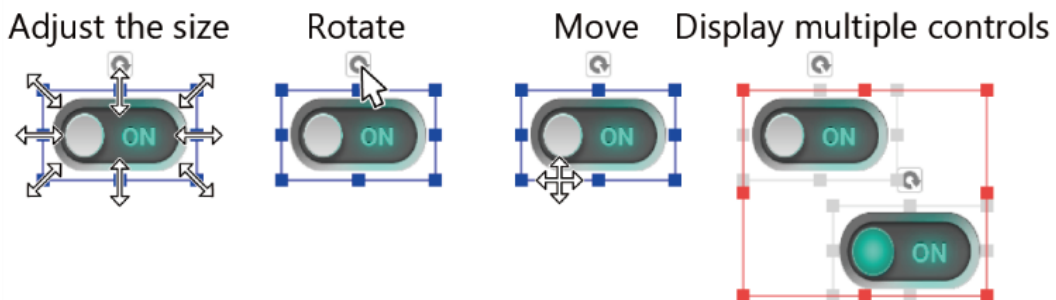

◆ Copy and Delete Controls

Right-click the activated control to show the editing menu. In this menu, such as copying or deleting controls can be performed.



◆ Configure the Layer

Select "Layer" tab at the upper right on the screen to open the layer properties.

In the "Settings" of the layer properties area, click the [...] button to open the dialog box.

You can set a size of monitoring screen or the background here.

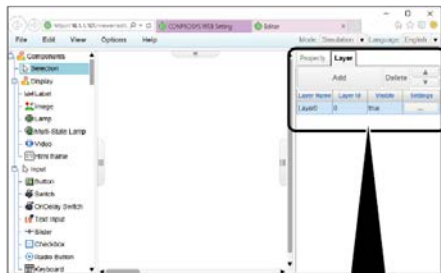

Layer tab

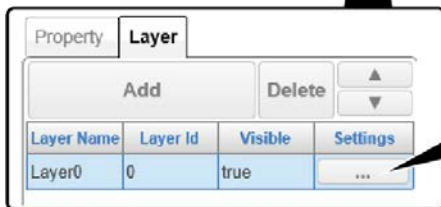

Layer setting

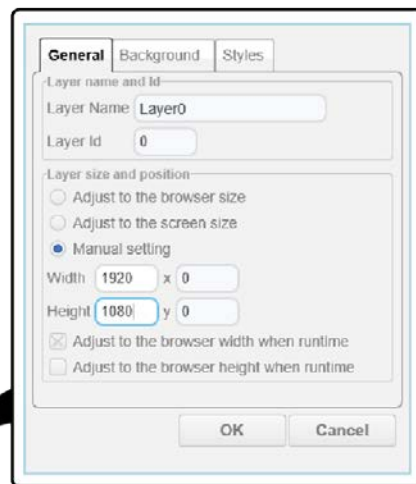

◆ JavaScript

You can enter code using JavaScript as necessary.

If a particular control logic is needed to run the system, code the behaviors of the system using JavaScript in "JavaScript" area.

Refer to "**Online Help**" for usable JavaScript functions for each control.

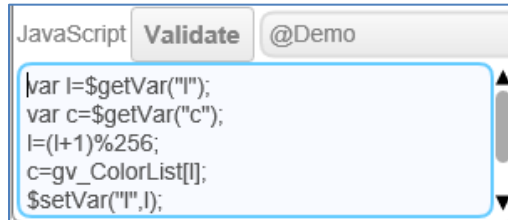

```
var l=$getVar("l");
var c=$getVar("c");
l=(l+1)%256;
c=gv_ColorList[l];
$setVar("l",l);
```

◆ Save the Settings to ROM.

After creating the monitoring screen, save the file with a new name.

After saving, perform "Save to ROM" in [File] before shutting down the power.

- * If you do not save the settings to ROM, the contents return to those before setting upon rebooting or shutting down.

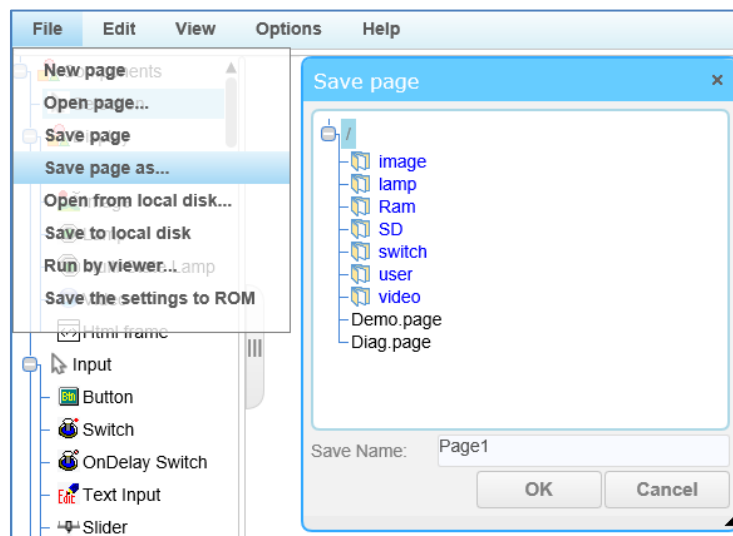

Refer to "Online help" for detailed CONPROSYS VTC operations and functions.

Online Help

<http://data.conprosys.com/help/task/V1/en/>

Revision History

MONTH YEAR	Summary of Changes
July 2018	The First Edition

CONTEC CO., LTD. 3-9-31, Himesato, Nishiyodogawa-ku, Osaka 555-0025, Japan

<https://www.contec.com/>

No part of this document may be copied or reproduced in any form by any means without prior written consent of CONTEC CO., LTD.

Setup Manual Configurable Type

[07202018]

July 2018 Edition