

4ch Analog Input  
Terminal for Sub-GHz Wireless  
EU model  
**AI-1004LY-WQ-EU**  
USA model  
**AI-1004LY-WQ-US**



- \* The photograph is a AI-1004LY-WQ-US.
- \* Specifications, color and design of the products are subject to change without notice.
- \* The contents in this document are subject to change without notice.
- \* Visit the CONTEC website to check the latest details in the document.
- \* The information in the data sheets is as of June, 2022.

## Features

### - Supports Sub-GHz band wireless with excellent transmission distance

This product converts the input signals wirelessly in the Sub-GHz band and transmits to the gateway. From the LAN port of a PC, analog signals ( $\pm 10V$ ) can be easily input via the gateway. The Sub-GHz, with the good wraparound characteristics of radio waves, the transmission distance (about 1 km) can be extended even there are obstacles. Stable communication can be achieved even in the environment where radio waves are mixed. As the product is suitable for long distance communication, network can be constructed on the wide area in the facilities without cable wiring.

### - Highly reliable mesh communication

With wireless mesh technology, the communication continues by changing the routes automatically even when disconnection occurs, for example. Communication stability enables the wireless network to be strong against obstacles.

### - Adaptable to a wide range of temperature

This product is capable of operating in the temperature between  $-20$  and  $+ 60^{\circ}C$ . It can be installed in the various environments.

### - Compact design

Compact design, 62.0(W) x 64.0(D) x 24.0(H)mm features flexibility in installation.

### - Easy mounting on DIN rail

This product can be mounted on DIN rail with an optional fixing bracket.

### - Capable of adapting a wide-range power

This product is capable of dealing with a wide range of power in the differing environments.

### - 4-channel analog input

4 channels of analog input with  $\pm 10V$  range, single-ended, and 10-bit resolution can be performed.

### - No adjustment for analog input

This product does not require analog input adjustment. Even the ambient temperature is  $-20^{\circ}C$  or  $+ 60^{\circ}C$ , sampling with accuracy of  $\pm 10$  LSB can be carried out without adjustment.

This product is an analog input terminal that sends input analog signals wirelessly in the Sub-GHz band. \*1 Data is sent to Ethernet gateway (Master) of the Wireless I/O series.

With strength against obstacles, capability of long-distance communications in the Sub-GHz band, and mesh support, it is suitable to control or monitor devices that are spread in the wide area.

4 channels of 10-bit non-isolated analog input are equipped to support  $\pm 10V$  bipolar input. This product provides excellent cost performance afforded by focusing on solely analog input function.

With the provided driver library API-AIO(WDM), you can create application software for Windows using various programming languages supporting Win32 API functions such as Visual Basic and Visual C ++.

\*The interval for transmitting data to the Master can be set to between 10 and 3600 seconds.

\*This product should always be used along with the Wireless I/O series Ethernet gateway (Master).

\*Driver library can be downloaded from the Contec website.

\*AI-1004LY-WQ-US can be used in the United States. AI-1004LY-WQ-EU can be used in European countries.

\*1 Sub-GHz indicates frequency bands of 1GHz and below. Available frequency band of the product depends on the model. The AI-1004-WQ-EU can be used in the 868MHz band (Europe), and the AI-1004LY-WQ-US can be used in the 915MHz band (The United States)

## Packing List

- Product [AI-1004LY-WQ-EU or AI-1004LY-WQ-US] ...1
- Setup Guide ...1
- Warranty Certificate ...1
- Serial Number Label ...1
- Power Connector ...1
- Antenna ...1

## List of Options

POA201-10-2	AC-DC Power Adaptor (12VDC, 1A) *1
BRK-WQ-Y	Bracket for Wireless I/O Products
CN6-Y14	14pin Screw Terminal Connector Set (6 pieces)

\*1 The adaptor can be used in the temperature range between 0 and  $+ 40^{\circ}C$ . The support voltage of AC cable is 125 VAC 7 A.

\* Visit CONTEC website regarding information on the optional products.

## Supported OS

Windows version analog input driver **API-AIO(WDM)**

Driver software with Win32API function (DLL) to support the function is ready to use per terminal.

The driver software contains sample programs such as VisualBasic and VisualC++, and the diagnosis program to check the software operation.

## Specifications

### Hardware specification

Item		AI-1004LY-WQ-EU	AI-1004LY-WQ-US
Wireless	Modulation system	GFSK	
	Speed *1	10kbps (Low data rate) / 80kbps (High data rate)	10kbps (Low data rate) / 110kbps (Middle data rate) / 250kbps (High data rate)
	Output	13dBm	
	Used frequency	863 - 870MHz	902 - 928MHz
Analog input	Isolated specification	Unisolated	
	Input type	Single-Ended Input	
	Number of input channels	4ch	
	Input range	Bipolar ±10V	
	Maximum input rating	±15V	
	Input impedance	1MΩ or more	
	Resolution	10bit	
	Non-Linearity error	±10LSB *2 *6	
	Conversion speed	10μsec/ch *3	
	Interface connector	European type terminal 3.5 pitch 14-pin jack connector	
	Applicable wire	AWG28 - 16	
USB	Bus specification	USB Specification 2.0/1.1-compliant	
	Data transmission speed	12Mbps (Full speed), 480Mbps (High speed)	
	Function	USB device	
	Connector	mini-B USB connector	
Antenna	Non-directional dipole antenna (2.0±0.7dBi)		
Power supply	Input voltage range	12 - 24VDC±5%	
	Current consumption	110mA (at 12VDC input) (Max), 70mA (at 24VDC input) (Max)	110mA (at 12VDC input) (Max), 60mA (at 24VDC input) (Max)
	Power connector *4	European type terminal 3.5 pitch 3-pin jack connector	
Physical dimensions (mm)	62.0(W) x 64.0(D) x 24.0(H) (No projection included)		
Weight	100g (Body), 150g (With bundled antenna, power connector, Interface connector)		

\*1 It is a theoretical maximum value on wireless communication and does not indicate the actual data speed.

\*2 When using the signal source equipped with the high-speed operational amplifier.

\*3 This numerical displays the conversion speed for A/D converter. The minimum executable sampling cycle depends on the operating condition of the terminal.

\*4 This product cannot be used with USB bus power. Make sure to use the external power that supplies 12VDC or 24VDC voltage.

### Environmental Specifications

Item		AI-1004LY-WQ-EU	AI-1004LY-WQ-US
Operating ambient temperature		-20 - +60°C *5	
Operating ambient humidity		10 - 90%RH (No condensation)	
Floating dust particles		Not to be excessive	
Corrosive gases		None	
Line-noise resistance *6	Line noise	AC Line/±2kV, Signal Line /±1kV (IEC61000-4-4 Level 3, EN61000-4-4 Level 3)	
	Static electricity resistance	Touch /±4kV(IEC61000-4-2 Level 2, EN61000-4-2 Level 2) Air /±8kV(IEC61000-4-2 Level 3, EN61000-4-2 Level 3)	
Vibration resistance	Sweep resistance	10 - 57Hz /semi-amplitude vibration 0.15mm, 57 - 150Hz/2.0G 40minutes each in X, Y, and Z directions (JIS C60068-2-6-compliant, IEC60068-2-6-compliant)	
	Shock resistance	147m/s <sup>2</sup> (15G)/11ms/half-sine shock (JIS C 60068-2-27 -compliant, IEC 60068-2-27 -compliant)	
Allowable length of instantaneous power failure *6		Within 17 milliseconds (100VAC@25°C), The product is automatically reset upon low voltage detection.	
Standard		CE Marking (EMC Directive Class A, RoHS Directive), UKCA	FCC Class A, RoHS Directive

\*5 When using an optional AC adapter POA201-10-2, the ambient temperature is 0 - 40°C.

\*6 When using an optional AC adapter POA201-10-2.

## Interface Connector

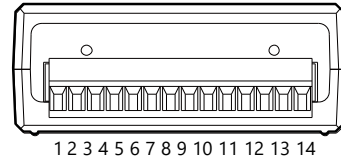

Attached connector: European type terminal 3.5 pitch 14-pin jack connector  
 Supplied connector: European type terminal 3.5 pitch 14-pin plug connector  
 Compatible cable: AWG28-16(Cable length should satisfy the power specification including the cable voltage drop)

Pin number	Signal name	Description
14	AGND	This indicates the analog ground and shares with input signals.
13	N.C.	This is left unconnected.
12	AGND	This indicates the analog ground and shares with input signals.
11	AI00	This indicates analog input signals. It connects output signals from the other devices. The number corresponds to the channel number.
10	AI01	
9	AI02	
8	AI03	This indicates the analog ground and shares with input signals.
7	AGND	
6	AGND	
5	N.C.	This is left unconnected.
4	N.C.	
3	N.C.	
2	N.C.	This indicates the analog ground and shares with input signals.
1	AGND	

## Input signal connection

### Input circuit

Analog signal input types are divided into single-ended input and differential input. This product uses single-ended input fixed. The following examples show how to connect analog input signals using a flat cable and a shielded cable.

The following figure shows an example of flat cable connection. Connect the signal source and the ground to each analog input channel of interface connector.

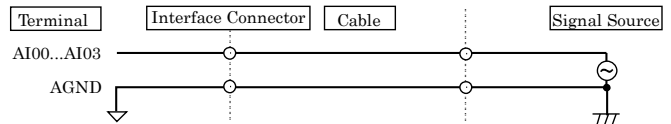

\*Input terminal is AI-xx.

The following figure shows an example of shield cable connection. Use shielded cable if the distance between the signal source and product is long or if you want to provide better protection from noise. For each analog input channel, connect the core wire to the signal line and connect the shielding to ground.

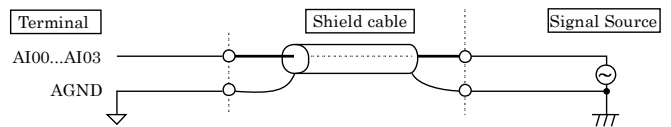

\*Input terminal is AI-xx.

### Caution

- If the signal source contains over 1MHz signals, the signal may effect the cross-talk noise between channels.
- If the product and the signal source receive noise or the distance between the product and the signal source is too long, data may not be input properly.
- An input analog signal should not exceed the maximum input voltage (relate to the product analog ground). If it exceeds the maximum voltage, the product may be damaged.
- Connect all the unused analog input channels to analog ground.

**Physical Dimensions**

Product

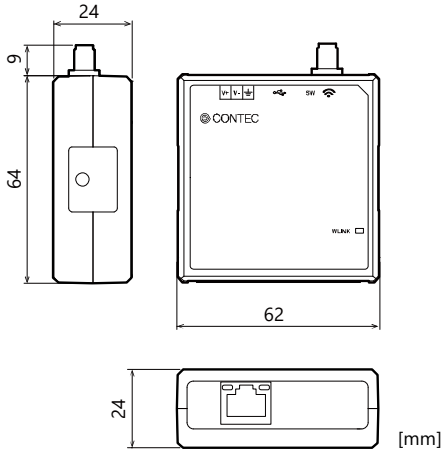

E-Plane (868MHz)

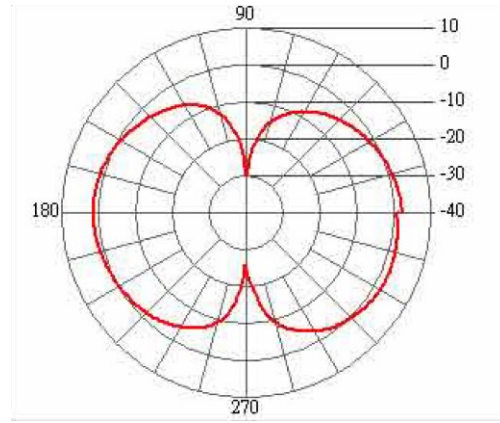

Antenna (AI-1004LY-WQ-EU)

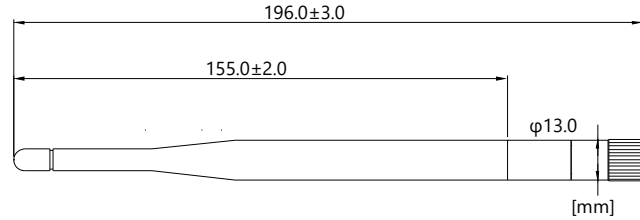

AI-1004LY-WQ-US

H-Plane (925MHz)

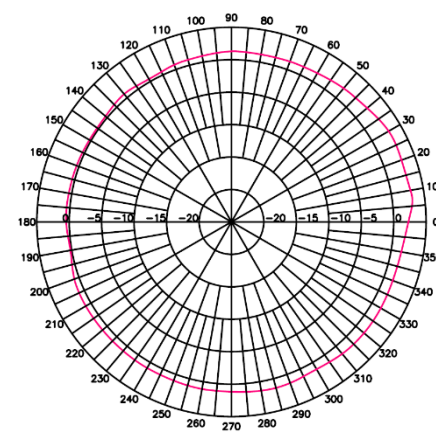

Antenna (AI-1004LY-WQ-US)  
(176)

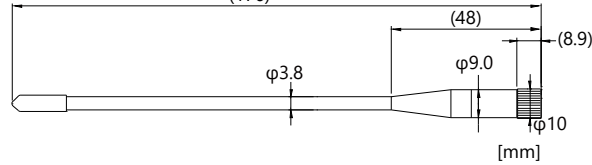

E-Plane (925MHz)

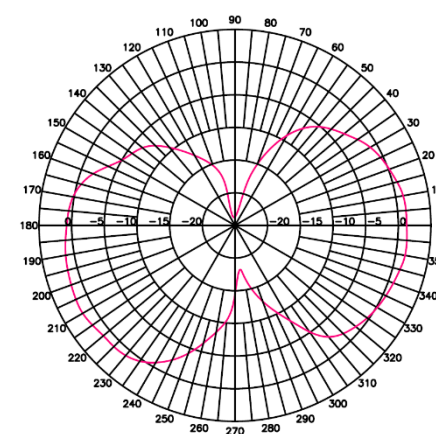

**Antenna Directivity**

AI-1004LY-WQ-EU

H-Plane (868MHz)

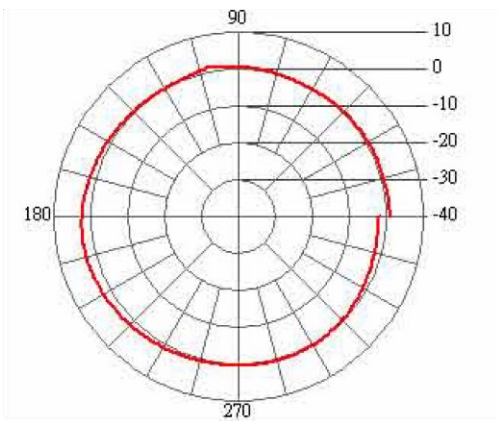

**Component Name**

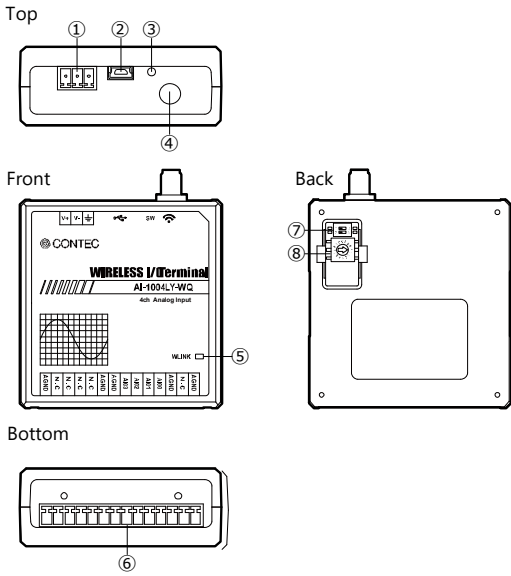

No.	Name
1	Power connector
2	mini-B USB connector
3	INIT button
4	Antenna connector
5	WLINK LED
6	Interface connector
7	DIP switch (for maintenance) *1
8	Rotary switch

\*1 Do not touch DIP switch since this is not used for usual operations.  
There is a cover for the switch on the back side of the product.