

High-Resolution Analog Input Terminal
for USB2.0
AI-1608GY-USB



* Specifications, color and design of the products are subject to change without notice.

Features

- **Equipped with the analog input 8ch and digital I/O 4ch each**
Equipped with the analog input (4μsec/ch, 16bit, 8ch) and digital I/O (4ch each, LVTTTL level).

- **Compatible to USB2.0/USB1.1 and not necessary to power this product externally as the bus power is used**
Compatible to USB2.0/USB1.1 and capable to achieve high speed transfer at HighSpeed (480 Mbps). Not necessary to power this product externally as the bus power of USB is used.

- **Equipped with the buffer memory which can be used in either FIFO or ring format**
This product includes buffer memory (8K data for analog input) which can be used in either FIFO or ring format. You can perform analog input in the background, independent of software and the current status of the PC.

- **Sampling can be driven by a clock or by various triggers**
Sampling can be started and stopped by software or by an external trigger (timing controlled by an externally input control signal). The sampling/generating period can be controlled by the internal clock (high-precision timer included on the board) or by an external clock (externally input control signal).

- **Terminal connector facilitating wiring**
Wiring is easy as the terminal connector (screw type) is used.

- **Software-based adjustment function**
Adjustment of analog input can be all performed by software. Apart from the adjustment information prepared before shipment, additional adjustment information can be stored according to the use environment.

- **Windows/Linux support device driver**
Using the device driver API-TOOL makes it possible to create applications of Windows/Linux. In addition, a diagnostic program by which the operations of hardware can be checked is provided.

Included Items

- Product...1
- Interface connector...2
- USB Cable(1.8m)...1
- USB Cable Attachment...1
- Please read the following...1

This product is a USB2.0 compatible terminal module that extends the analog I/O function of USB port of PCs. 8ch/16bits analog inputs are employed and signal lines can be directly connected to the screw terminals in the system. Compact design to match Note PCs and excellent in mobility as operation is powered by USB bus.

Windows/Linux device driver is supported with the product.

- * The contents in this document are subject to change without notice.
- * Visit the CONTEC website to check the latest details in the document.
- * The information in the data sheets is as of July, 2024.

Specifications

Function specification

Item	Specifications
Analog input	
Isolated specification	Unisolated
Input type	Single-Ended Input
Number of input channels	8ch
Input range	Bipolar ±10V
Maximum input voltage	±20V
Input impedance	1MΩ or more
Resolution	16bit
Non-linear error *1*2	±12LSB
Conversion speed	4μsec/ch (Max) *3
Buffer memory	8K data
Conversion start trigger	Software / external trigger
Conversion stop trigger	Number of sampling times / external trigger / software
External start signal	LVTTTL level (Selecting the rising / falling edge to the DI00-pin by the software)
External stop signal	LVTTTL level (Selecting the rising / falling edge to the DI01-pin by the software)
External clock signal	LVTTTL level (Selecting the rising / falling edge to the DI02-pin by the software)
Digital I/O	
Number of input channels	Unisolated input 4ch (LVTTTL positive logic) *4*5
Number of output channels	Unisolated output 4ch (LVTTTL positive logic)
USB	
Bus specification	USB Specification 2.0/1.1 standard
USB transfer rate	12Mbps (Full-speed), 480Mbps (High-speed) *6
Power supply	Bus power
Common section	
Number of terminals used at the same time	127 terminals (Max) *7
Power consumption	5VDC 375mA (Max)
Physical dimensions (mm)	64(W) x 62(D) x 24(H) (exclusive of protrusions)
Weight	90g (Not including the USB cable, attachment)
Attached cable	USB cable 1.8m

- *1 The non-linearity error means an error of approximately 0.1% occurs over the maximum range at 0°C and 50°C ambient temperature. The error can be reduced by calibrating under the actual temperature conditions.
- *2 When using the signal source equipped with the high-speed operational amplifier.
- *3 This numerical displays the conversion speed for A/D, D/A converter. The minimum executable sampling cycle depends on the operating condition of the terminal.
- *4 You cannot use both the DI00 / DI01 / DI02-pin of digital input feature and the external start / stop signal / external clock input simultaneously.
- *5 Each input accept TTL (5VDC) level signals.
- *6 The USB transfer speed depends on the host PC environment used (OS and USB host controller).
- *7 As a USB hub is also counted as one device, you cannot just connect 127 USB terminals.

Installation Environment Requirements

Item	Specifications
Operating ambient temperature	0 - 50°C
Operating ambient humidity	10 - 90%RH (No condensation)
Floating dust particles	Not to be excessive
Corrosive gases	None
Standard	VCCI Class A, FCC Class A, CE Marking (EMC Directive Class A, RoHS Directive), UKCA

Physical Dimensions

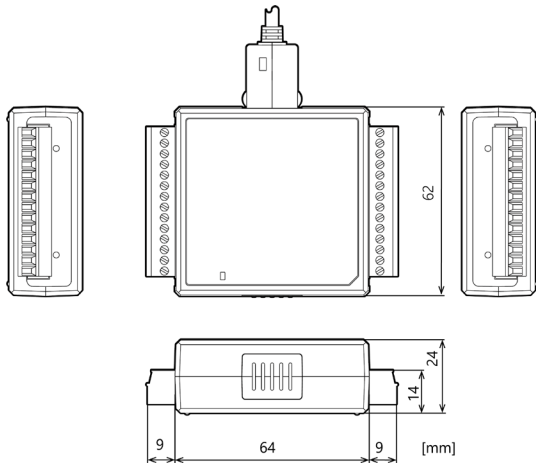

Optional Products

Product Name	Model type	Note
14pin Screw Terminal Connector Set	CN6-Y14	6 pieces
Bracket for USB I/O Terminal products	BRK-USB-Y	

Visit the CONTEC website for the latest optional products.

Support Software

Name	Contents	How to get
Windows Version Analog I/O Driver software API-AIO(WDM)	The API-AIO(WDM) is the Windows version driver software that provides products in the form of Win32 API functions (DLL). Various sample programs such as Visual Basic and Visual C++, etc and diagnostic program useful for checking operation is provided.	Download from the CONTEC website *1
Linux Version Analog I/O Driver software API-AIO(LNX)	This is the Linux version driver software provided in API function formats. The software includes various sample programs such as gcc (C, C++) and Python programs.	Download from the CONTEC website *1
Software Development Tool Kits (SDK) and Support Software	In addition to the device drivers, we offer many software programs for using CONTEC devices in an easier manner.	Download from the CONTEC website *2

*1 Download the files from the following URL
<https://www.contec.com/download/>

*2 For supported software, search the CONTEC website for this product and view the product page.
<https://www.contec.co>

External Connectio

Using the On-terminal Connector

To connect an external device to this terminal, plug the cable from the device into the interface connector (CN1, CN2) shown below.

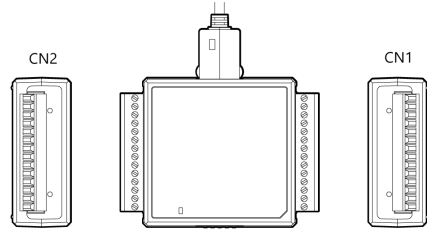

Layout on the Interface Connector(CN1, CN2)

CN2			CN1		
AGND	1		14	AGND	
AI 07	2		13	N.C.	
AI 06	3		12	AGND	
AI 05	4		11	N.C.	
AI 04	5		10	DI 00	
AGND	6		9	DI 01	
AGND	7		8	DI 02	
AI 03	8		7	DI 03	
AI 02	9		6	DGND	
AI 01	10		5	DO 00	
AI 00	11		4	DO 01	
AGND	12		3	DO 02	
N.C.	13		2	DO 03	
AGND	14		1	DGND	

AI 00 - AI 07	Analog input signal. The numbers correspond to channel numbers.
AGND	Common analog ground for analog I/O signals.
DI 00 - DI 03	Digital input signal. The numbers correspond to input bits.
DO 00 - DO 03	Digital output signal. The numbers correspond to output bits.
DGND	Common digital ground for digital I/O signals

CAUTION

- Do not connect any of the outputs and power outputs to the analog or digital ground. Neither connect outputs to each other. Doing either can result in a fault
- If analog and digital ground are shorted together, noise on the digital signals may affect the analog signals. Accordingly, analog and digital ground should be separated.

Cable connection

When connecting the product to an external device, you can use the supplied connector plug.

For wiring, strip off approximately 9 - 10mm of the covered part of a wire rod and then insert it to the opening. After the insertion, secure the wire rod with screws. Compatible wires are AWG 28 - 16.

CAUTION

Removing the connector plug by grasping the cable can break the wire.

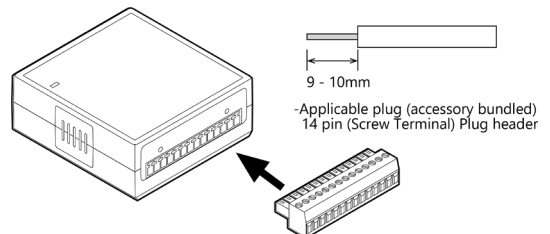

Connecting Analog Input Signal

Analog signal input types are divided into single-ended input and differential input. This product uses single-ended input fixed. The following examples show how to connect analog input signals using a flat cable and a shielded cable.

Single-ended Input

Connection example with flat cable

The following figure shows an example of flat cable connection. Connect separate signal and ground wires for each analog input channel on CN2.

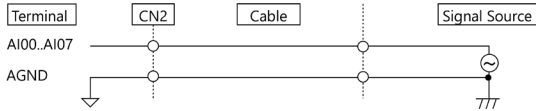

Connection example with shield cable

The following figure shows an example of shield cable connection. Use shielded cable if the distance between the signal source and product is long or if you want to provide better protection from noise. For each analog input channel, connect the core wire to the signal line and connect the shielding to ground.

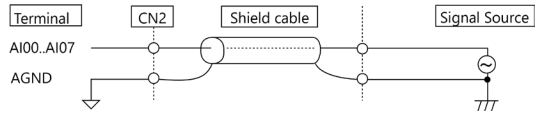

CAUTION

- If the signal source contains over 1MHz signals, the signal may effect the cross-talk noise between channels.
- If the product and the signal source receive noise or the distance between the product and the signal source is too long, data may not be input properly.
- An input analog signal should not exceed the maximum input voltage (relate to the product analog ground). If it exceeds the maximum voltage, the product may be damaged.
- Connect all the unused analog input channels to analog ground.
- The signal connected to an input channel may fluctuate after switching of the multiplexer. In this case, the cable between this product and the signal source can be shortened or a buffer with a high-speed amplifier can be placed between the product and the signal source in order to reduce the fluctuation.

Connecting Digital I/O Signals

The digital I/O signal can be used as the control signal (external trigger input signal and sampling clock input signal, etc.), too. The following sections show examples.

All the digital I/O signals are LVTTTL (3.3VDC) level signals.

Digital Input Connection

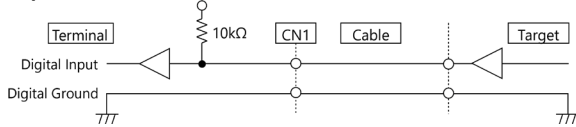

Digital Output Connection

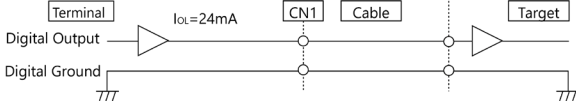

CAUTION

Do not short the output signals to analog ground, digital ground, and/or power line. Doing so may damage the terminal. Each input accepts 5V TTL level signals.

Circuit Block Diagram

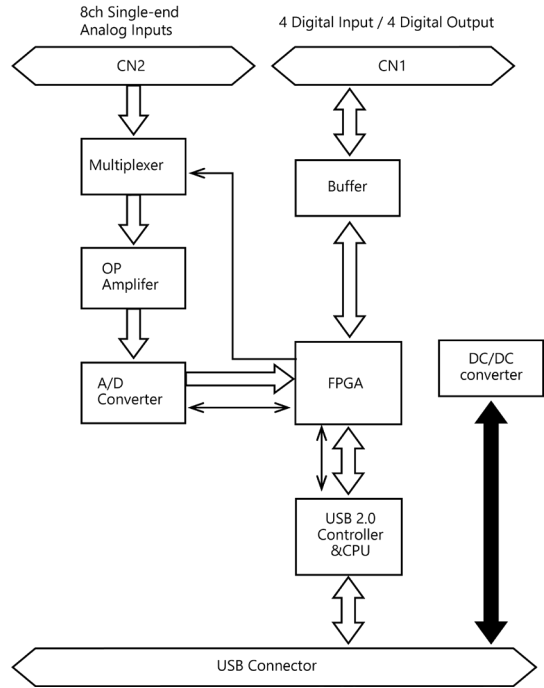

Component Name

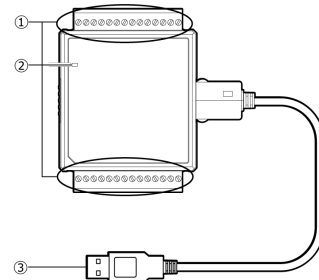

No.	Name	No.	Name
1	Interface Connector	3	USB Type-A Connector
2	LED Indicator		