

1MSPS 16-bit Analog Input Board for PCI Express AI-1664UG-PE

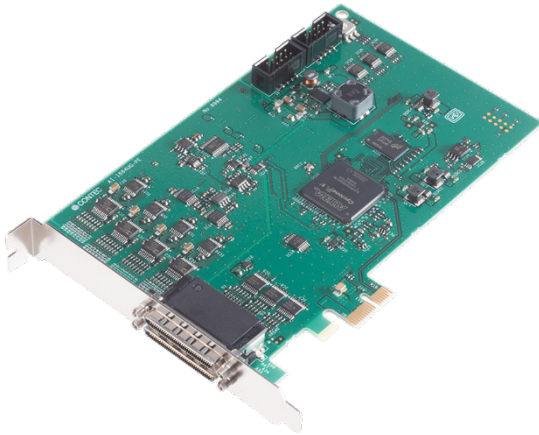

* Specifications, color and design of the products are subject to change without notice.

Features

High-performance, multifunction single DAQ device with analog input and digital input/output and counter functions

This high-performance multi-function device includes 64 single-ended 16-bit analog inputs (32 differential channels) as well as 8 digital inputs and outputs and a 32-bit counter channel.

The product enables measurement control in a compact, reasonably priced package for systems requiring a variety of signal inputs and outputs.

DMA bus master transfer function for high-speed, continuous sampling

The DMA bus master transfer function, which allows data to be directly transferred to the PC memory, enables continuous sampling for long periods without affecting the device's maximum conversion speed.

When analog input data is transferred using the bus master transfer function, simultaneous transferring of various data is also possible, including digital input, digital output, and counter data synchronized with analog input clock signals.

This makes the product ideal for component inspection equipment and measurement testing benches that require high-speed data acquisition over long periods.

Built-in event controller for advanced synchronization control

The built-in event controller enables integrated management of the triggers and statuses of each signal input and output, enabling hardware-level synchronization control of signal inputs and outputs.

As a result, the product is ideal for factory automation and mixed-signal testing applications requiring low-latency, real-time responsiveness.

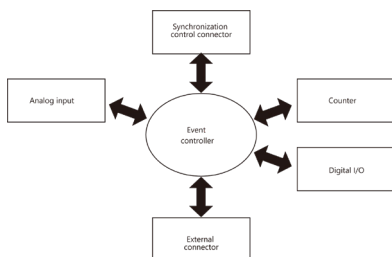

Scenario 1: Connect two devices with synchronization control connector, synchronize with analog input of one device, and perform analog input of the other device.

Scenario 2: Analog input performed whenever the counter value reaches the set value.

Synchronized operation of up to 16 devices (connection via synchronization control connector)

Synchronized operation of up to 16 devices is possible with no need for external wiring or clock synchronization.

Simply connect the devices via the synchronization control connector and a dedicated cable to enable synchronized operation using the event controller. Synchronized operation is also possible with other Contec devices featuring a synchronization control connector (such as the DIO-

The product is a PCI Express-compliant data acquisition (DAQ) device with high-speed, high-precision, multi-channel analog input functionality. In addition to analog input, this multi-function device is equipped with digital input/output, and a counter, enabling measurement control in a compact, reasonably priced package for systems requiring a variety of signal inputs and outputs. The DMA bus master transfer function also enables continuous sampling for long periods without affecting the device's maximum conversion speed. This makes the product ideal for component inspection equipment and measurement testing benches that require high-speed data acquisition over long periods.

In addition, thanks to the event controller's ability to perform hardware-level integrated management of the trigger, clock, and status of each signal input/output, synchronous signal input/output control—difficult to achieve at the software level—is possible. As a result, the product is ideal for factory automation and mixed-signal testing applications requiring low-latency, real-time responsiveness.

- * The contents in this document are subject to change without notice.
- * Visit the CONTEC website to check the latest details in the document.
- * The information in the data sheets is as of June, 2023.

32DM3-PE and CNT-3208M-PE).

Jumper-less, trim-less configuration (software configuration)

Software-based configuration of input range, accuracy calibration, and digital filtering settings is possible while the product is installed on the computer.

- Analog input range settings: $\pm 10V$, $\pm 5V$, $\pm 2.5V$
0 - +10V, 0 - +5V, 0 - +2.5V
- Analog input calibration settings: Factory default or user preset
- Digital filtering setting (external trigger/clock, digital input, counter):
0 - 16000 μ s

Interface connector shape and signal pin assignments compatible with the AD16-64(LPCI)LA, AI-1664LA-LPE, and AI-1664LAX-USB

This device is functionally upward compatible with nearly identical functions as the PCI-compatible AD16-64(LPCI)LA card, the PCI-Express-compatible AI-1664LA-LPE card, and the USB-compatible AI-1664LAX-USB unit with conversion speeds of 1 μ sec/ch as well as bus master transfers.

The connector shape and signal pin assignments are also compatible, enabling easy migration from a conventional system.

Extensive support software

Device driver for Windows / Linux API-TOOL (Free download)

The API-TOOL device driver/SDK for Windows and Linux, which includes programming API, online help, sample programs, and hardware diagnostic programs, is available to download for free.

Data Logger Software C-LOGGER (Free download)

The Analog G Series is compatible with Contec's C-LOGGER data logger software designed to bring out the best of Contec's analog measurement devices. Take advantage of graphical displays of acquired data, zoomed observation, file saving, and dynamic transferring of data to Excel (spreadsheet software) with no programming required.

DAQfast LabVIEW data acquisition library DAQ-LV-WIN (Free download)

This data recording library makes it possible to use the product with LabVIEW from National Instruments. Polymorphic VIs make using the product simple for LabVIEW users, ensuring the desired operations can be performed quickly and effortlessly.

.NET component collection for DAQfast measurement system development DAQ-DNC-FE (Free download)

This measurement system development support tool is compatible with the Visual Studio integrated development environment. This makes it possible to configure device settings, acquire data, and link data between components with no coding necessary, enabling a highly productive low-code development environment.

Specifications

Function specification

Item	Description	
Analog input	Isolated specification	Un-Isolated
	Input type	Single-Ended Input or Differential Input (by software)
	Number of input channels	64ch (Single-Ended Input), 32ch (Differential Input)
	Input range	Bipolar $\pm 10V$, $\pm 5V$, $\pm 2.5V$ or Unipolar 0 - +10V, 0 - +5V, 0 - +2.5V
	Absolute max input voltage *1	$\pm 15V$ (Max)
	Input impedance	1M Ω or more
	Resolution	16bit
	Non-Linearity error *1*2	Within $\pm 5LSB$
	Conversion speed	1 μ sec/ch (Max)
	Buffer memory	128M Word FIFO or 128M Word RING
	Conversion start trigger	Software, conversion data compare, external trigger, and event controller output
	Conversion stop trigger	Data save complete, conversion data compare, external trigger, event trigger
	External start signal	LVTTTL level (Rising or falling edge can be selected by software) Digital filter (select 1 μ sec by software)
	External stop signal	LVTTTL level (Rising or falling edge can be selected by software) Digital filter (select 1 μ sec by software)
External dock signal	LVTTTL level (Rising or falling edge can be selected by software) Digital filter (select 1 μ sec by software)	
Digital I/O section	Number of input channels	Un-Isolated input 4 channels (LVTTTL-level positive logic)
	Number of output channels	Un-Isolated output 4 channels (LVTTTL-level positive logic)
	Response time	200nsec (Max)
Counter	Number of channels	1ch
	Counting system	Up count
	Max. count	FFFFFFFF (Binary data, 32bit)
	Number of external inputs	2 LVTTTL level (Gate/Up)/ch, Gate (High level), Up (Rising edge)
	Number of external outputs	1 LVTTTL level, Count match output (positive logic, pulse output)
	Frequency response	10MHz (Max)
Bus master section	DMA channels	1ch(for input)
	Transfer bus width	64/32bit
	Transfer data length	360MByte/s
	FIFO	8k Word/ch
	Scatter/Gather function	2G Byte/ch
Synchronization bus section	Control output signal	Selection of output signal with the software when specifying a sync master product.
	Control input signal	Selection of sync factor with the software when specifying sync slave products.
	Max. product count for connection	16 products including the master product
Common section	Memory address	Occupies 2 locations 256MByte
	Current consumption	3.3V 1800mA (Max)
	Operating condition	0 - 50°C, 10 - 90%RH (No condensation)
	Bus specification	PCI Express Base Specification Rev.2.0 x1
	Dimension (mm)	169.33(L) x 110.18(H)
	Weight	130g

*1 The non-linearity error means an error of approximately 0.1% occurs over the maximum range at 0°C and 50°C ambient temperature.

*2 At the time of the source use of a signal which built in the high-speed operational amplifier.

Installation Environment Requirements

Item	Description
Operating ambient temperature	0 - +50°C
Operating ambient humidity	10 - 90%RH (No condensation)
Floating dust particles	Not to be excessive
Corrosive gases	None
Standard	VCCI Class A, CE Marking (EMC Directive Class A, RoHS Directive), UKCA

Support Software

Name	Contents	How to get
Windows version High-efficiency Analog I/O Driver API-AIO(WDM)	The API-AIO(WDM) is the Windows version driver software that provides products in the form of Win32 API functions (DLL). Various sample programs such as Visual Basic and Visual C++, etc and diagnostic program useful for checking operation is provided.	Download from the CONTEC website
Analog I/O Driver for Linux API-AIO(LNX)	This is the Linux version driver software provided in API function formats. The software includes various sample programs such as gcc (C, C++) and Python programs.	Download from the CONTEC website
Data Logger Software C-LOGGER	C-LOGGER is a data logger software program compatible with our analog input products. This program enables the graph display of recorded signal data, zoom observation, file saving, and dynamic transfer to the spreadsheet software "Excel". No troublesome programming is required.	Download from the CONTEC website
LabVIEW VI Library for Data Acquisition DAQ-LV-WIN	This is a data acquisition library to use our devices in the LabVIEW by National Instruments. With Polymorphic VI, our design enables a LabVIEW user to operate seamlessly. Our aim is for the customers to perform easily, promptly what they wish to do.	Download from the CONTEC website
.NET component collection for DAQfast measurement system development DAQ-DNC-FE	A GUI-based measurement system development support tool compatible with the Visual Studio low-code integrated development environment. It contains a collection of components that are very useful for developing applications using Contec's wealth of measurement control devices in the PC-HELPER series (PCIe/PCI, USB, Ethernet) and the industrial IoT CONPROSYS™ nano series.	Download from the CONTEC website

Optional Products

Product Name	Model type	Description
Screw Terminal	DTP-64A *1	M3 x 96P
	EPD-96A *1*2*4	M3 x 96P
	EPD-96 *1*2	M3.5 x 96P
	EPD-68A *2*3*4	M3 x 68P
Termination Panel with BNC connectors for Analog I/O Boards	ATP-32F *1*2	for analog input 32ch
	ATP-B *1*2*5	for analog input 8ch
68pin 0.8mm Pitch Connector to Open-Ended, Shield Cable	PCA68PS-0.5P	0.5m
	PCA68PS-1.5P	1.5m
Both sides with connector shield cable for 68 pin 0.8mm pitch connectors	PCB68PS-0.5P	0.5m
	PCB68PS-1.5P	1.5m
Shield Cable for Analog I/O Card for CardBus	ADC-68M/96F	0.5m

*1 ADC-68M/96F optional cable is required separately.

*2 Two sets of cables are required to use both connector CNA and CNB.

*3 PCB68PS-0.5P or PCB68PS-1.5P optional cable is required separately.

*4 "Screw upright terminal panel" is used to prevent terminal screws from falling off.

*5 Can be used in CNA channels 0 - 7 or CNB channels 32 - 39.

* Information about the option products, see the Contec's website.

Included Items

Product [AI-1664UG-PE] ... 1
Synchronization Control Cable ... 1
Please read the following ... 1

External Dimensions

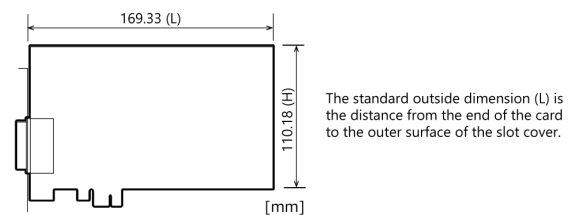

Component Name

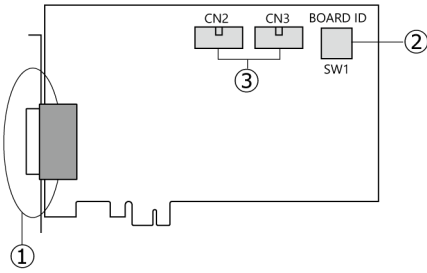

No.	Name	No.	Name
1	Interface Connector	3	Synchronous control connectors
2	Board ID Setting Switch		

Connecting an Interface Connector

To connect an external device to this product, plug the cable from the device into the interface connector (CNA, CNB) shown below.

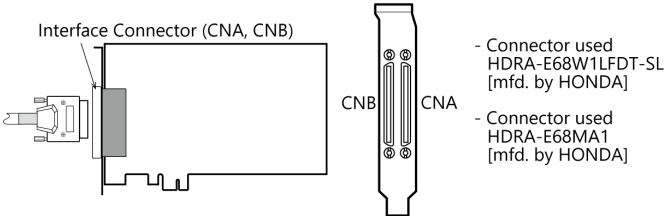

Adding Optional Products

Functions can be expanded by adding various dedicated optional products.

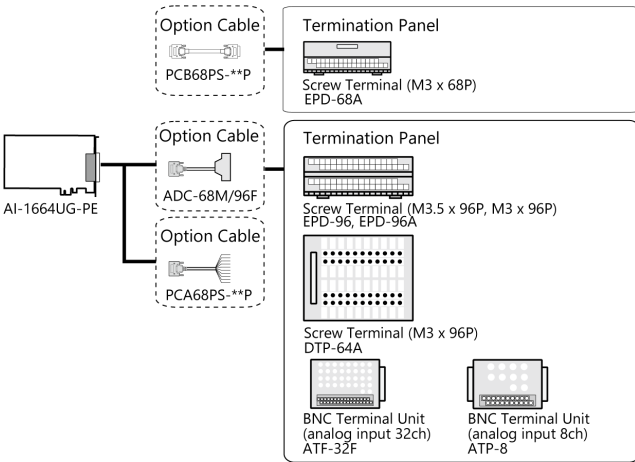

* Please refer to "Optional Products" for more information on the supported cable and accessories.

Each terminal block accepts the following ranges of channels.

	Connector at board side connection destination	Analog input		Analog input control signal *1	Digital input Digital output	Counter I/O *2
		Single-ended input	Differential input			
EPD-96A EPD-96 EPD-68A DTP-64	Only CNA is used.	channel 0 - 31	channel 0 - 15	○	○	○
	Only CNB is used.	channel 32 - 63	channel 16 - 31	○	○	○
	CNA/B is used *3	channel 0 - 63	channel 0 - 31	○ *4	○ *4	○ *4
ATP-32F	Only CNA is used.	channel 0 - 31	--	○	○	○
	Only CNB is used.	channel 32 - 63	--	--	--	--
	CNA/B is used *3	channel 0 - 63	--	○ *4	○ *4	○ *4
ATP-8	Only CNA is used.	channel 0 - 7	--	○	○	○
	Only CNB is used.	channel 32 - 39	--	--	--	--
	CNA/B is used *3	channel 0 - 7, 32 - 39	--	○ *4	○ *4	○ *4

- *1 AI External Start Trigger Input, AI External Stop Trigger Input, AI External Clock Trigger Input
- *2 Counter Gate Control Input, Counter Up Clock Input, Counter Output
- *3 Two sets of terminal blocks and optional cables are required each.
- *4 Make wiring on the CAN side.

Signal Pin Assignments on the Interface Connector (CNA, CNB)

Single-Ended Input

CNB				CNA			
N.C.	68		34	N.C.	1		35
N.C.	67		33	N.C.	2		36
N.C.	66		32	N.C.	3		37
N.C.	65		31	Analog Ground (for AI)	4		38
N.C.	64		30	Analog Input 00	5		39
N.C.	63		29	Analog Input 01	6		40
N.C.	62		28	Analog Input 02	7		41
Digital Ground	61		27	Analog Input 03	8		42
N.C.	60		26	Analog Ground (for AI)	9		43
N.C.	59		25	Analog Input 04	10		44
Digital Ground	58		24	Analog Input 05	11		45
N.C.	57		23	Analog Input 06	12		46
Analog Input 63	56		22	Analog Input 07	13		47
Analog Input 62	55		21	Analog Ground (for AI)	14		48
Analog Input 61	54		20	Analog Input 08	15		49
Analog Input 60	53		19	Analog Input 09	16		50
Analog Ground (for AI)	52		18	Analog Input 10	17		51
Analog Input 59	51		17	Analog Input 11	18		52
Analog Input 58	50		16	Analog Ground (for AI)	19		53
Analog Input 57	49		15	Analog Input 12	20		54
Analog Ground (for AI)	48		14	Analog Input 13	21		55
Analog Input 55	47		13	Analog Input 14	22		56
Analog Input 54	46		12	Analog Input 15	23		57
Analog Input 53	45		11	Input Control External Sampling Start Trigger Input	24		58
Analog Input 52	44		10	Input Control External Sampling Clock Input	25		59
Analog Ground (for AI)	43		9	Analog Input 16	26		60
Analog Input 51	42		8	N.C.	27		61
Analog Input 50	41		7	N.C.	28		62
Analog Input 49	40		6	Analog Input 17	29		63
Analog Input 48	39		5	Digital Input 00	30		64
Analog Ground (for AI)	38		4	Digital Input 01	31		65
Analog Input 37	37		3	Digital Output 00	32		66
Analog Ground (for AI)	36		2	Digital Output 01	33		67
Analog Input 35	35		1	Counter Gate Control Input	34		68
				Counter Clock Input			
				N.C.			

- The numbers in square brackets [] are pin numbers designated by HONDA TSUSHIN KOGYO CO.

Signal name	Description
Analog Input00 - Analog Input63	Analog input signal. The numbers correspond to channel numbers.
Analog Ground	Common analog ground for analog input signals.
AI External Start Trigger Input	External trigger input for starting analog input sampling.
AI External Stop Trigger Input	External trigger input for stopping analog input sampling.
AI External Sampling Clock Input	External sampling clock input for analog input.
Digital Input00 - Digital Input03	Digital input signal.
Digital Output00 - Digital Output03	Digital output signal.
Counter Gate Control Input	Gate control input signal for counter.
Counter Up Clock Input	Count-up clock input signal for counter.
Counter Output	Count output signal.
Digital Ground	Common digital ground for digital I/O signals, external trigger inputs, external sampling clock inputs, and counter I/O signals.
Reserved	Reserved pin.
N.C.	No connection to this pin.

CAUTION

- Do not connect any of the outputs and power outputs to the analog or digital ground. Neither connect outputs to each other. Doing either can result in a fault.
- If analog and digital ground are shorted together, noise on the digital signals may affect the analog signals. Accordingly, analog and digital ground should be separated.
- Leave "Reserved" pins unconnected. Connecting these pins may cause a fault in the product.

Single-Ended Input (ADC-68M/96F)

CNB				CNA			
N.C.	B01	A01	N.C.	N.C.	A48	B48	N.C.
N.C.	B02	A02	N.C.	Analog Ground (for AI)	A47	B47	N.C.
N.C.	B03	A03	N.C.	N.C.	A46	B46	N.C.
N.C.	B04	A04	N.C.	Analog Ground (for AI)	A45	B45	N.C.
N.C.	B05	A05	N.C.	Analog Input 00	A44	B44	Analog Input 08
N.C.	B06	A06	N.C.	Analog Input 16	A43	B43	Analog Input 24
N.C.	B07	A07	N.C.	Analog Input 01	A42	B42	Analog Input 09
Digital Ground	B08	A08	Digital Ground	Analog Input 17	A41	B41	Analog Input 25
N.C.	B09	A09	N.C.	N.C.	A40	B40	N.C.
N.C.	B10	A10	N.C.	N.C.	A39	B39	N.C.
N.C.	B11	A11	N.C.	Analog Input 02	A38	B38	Analog Input 10
N.C.	B12	A12	N.C.	Analog Input 18	A37	B37	Analog Input 26
N.C.	B13	A13	N.C.	Analog Input 03	A36	B36	Analog Input 11
N.C.	B14	A14	N.C.	Analog Input 19	A35	B35	Analog Input 27
N.C.	B15	A15	N.C.	Analog Ground (for AI)	A34	B34	Analog Ground (for AI)
N.C.	B16	A16	N.C.	Analog Ground (for AI)	A33	B33	Analog Ground (for AI)
N.C.	B17	A17	N.C.	Analog Input 04	A32	B32	Analog Input 12
N.C.	B18	A18	N.C.	Analog Input 20	A31	B31	Analog Input 28
N.C.	B19	A19	N.C.	Analog Input 05	A30	B30	Analog Input 13
N.C.	B20	A20	N.C.	Analog Input 21	A29	B29	Analog Input 29
Analog Ground (for AI)	B21	A21	Analog Ground (for AI)	N.C.	A28	B28	N.C.
Analog Ground (for AI)	B22	A22	Analog Ground (for AI)	N.C.	A27	B27	N.C.
Analog Input 63	B23	A23	Analog Input 55	Analog Input 06	A26	B26	Analog Input 14
Analog Input 47	B24	A24	Analog Input 39	Analog Input 22	A25	B25	Analog Input 30
Analog Input 62	B25	A25	Analog Input 54	Analog Input 07	A24	B24	Analog Input 15
Analog Input 46	B26	A26	Analog Input 38	Analog Input 23	A23	B23	Analog Input 31
N.C.	B27	A27	N.C.	Analog Ground (for AI)	A22	B22	Analog Ground (for AI)
N.C.	B28	A28	N.C.	Analog Ground (for AI)	A21	B21	Analog Ground (for AI)
Analog Input 61	B29	A29	Analog Input 53	N.C.	A20	B20	N.C.
Analog Input 45	B30	A30	Analog Input 37	N.C.	A19	B19	N.C.
Analog Input 60	B31	A31	Analog Input 52	Digital Input 00	A18	B18	Digital Output 00
Analog Input 44	B32	A32	Analog Input 36	Digital Input 01	A17	B17	Digital Output 01
Analog Ground (for AI)	B33	A33	Analog Ground (for AI)	Digital Input 02	A16	B16	Digital Output 02
Analog Ground (for AI)	B34	A34	Analog Ground (for AI)	Digital Input 03	A15	B15	Digital Output 03
Analog Input 59	B35	A35	Analog Input 51	N.C.	A14	B14	N.C.
Analog Input 43	B36	A36	Analog Input 35	N.C.	A13	B13	N.C.
Analog Input 58	B37	A37	Analog Input 50	N.C.	A12	B12	N.C.
Analog Input 42	B38	A38	Analog Input 34	N.C.	A11	B11	N.C.
N.C.	B39	A39	N.C.	N.C.	A10	B10	N.C.
N.C.	B40	A40	N.C.	N.C.	A09	B09	N.C.
Analog Input 57	B41	A41	Analog Input 49	Digital Ground	A08	B08	Digital Ground
Analog Input 41	B42	A42	Analog Input 33	Input Control External Sampling Clock Input	A07	B07	N.C.
Analog Input 56	B43	A43	Analog Input 48	Input Control External Sampling Stop Trigger Input	A06	B06	N.C.
Analog Input 40	B44	A44	Analog Input 32	Input Control External Sampling Start Trigger Input	A05	B05	N.C.
N.C.	B45	A45	Analog Ground (for AI)	Counter Clock Input	A04	B04	N.C.
N.C.	B46	A46	N.C.	Reserved (Counter Input)	A03	B03	N.C.
N.C.	B47	A47	Analog Ground (for AI)	Counter Gate Control Input	A02	B02	N.C.
N.C.	B48	A48	N.C.	Counter Count-up Pulse Output	A01	B01	N.C.

- The numbers in square brackets [] are pin numbers designated by HONDA TSUSHIN KOGYO CO.

Signal name	Description
Analog Input00 - Analog Input31	Analog input signal. The numbers correspond to channel numbers.
Analog Ground	Common analog ground for analog input signals.
AI External Start Trigger Input	External trigger input for starting analog input sampling.
AI External Stop Trigger Input	External trigger input for stopping analog input sampling.
AI External Sampling Clock Input	External sampling clock input for analog input.
Digital Input00 - Digital Input03	Digital input signal.
Digital Output00 - Digital Output03	Digital output signal.
Counter Gate Control Input	Gate control input signal for counter.
Counter Up Clock Input	Count-up clock input signal for counter.
Counter Output	Count output signal.
Digital Ground	Common digital ground for digital I/O signals, external trigger inputs, external sampling clock inputs, and counter I/O signals.
Reserved	Reserved pin.
N.C.	No connection to this pin.

CAUTION

- Do not connect any of the outputs and power outputs to the analog or digital ground. Neither connect outputs to each other. Doing either can result in a fault.
- If analog and digital ground are shorted together, noise on the digital signals may affect the analog signals. Accordingly, analog and digital ground should be separated.
- Leave "Reserved" pins unconnected. Connecting these pins may cause a fault in the product.

Differential Input (CNA, CNB)

CNB				CNA			
N.C.	68	34	N.C.	N.C.	1	35	Analog Ground (for AI)
N.C.	67	33	N.C.	N.C.	2	36	Analog Ground (for AI)
N.C.	66	32	N.C.	Analog Ground (for AI)	3	37	Analog Ground (for AI)
N.C.	65	31	N.C.	Analog Input 00[+]	4	38	Analog Input 00[-]
N.C.	64	30	N.C.	Analog Input 01[+]	5	39	Analog Input 01[-]
N.C.	63	29	N.C.	Analog Input 02[+]	6	40	Analog Input 02[-]
N.C.	62	28	N.C.	Analog Input 03[+]	7	41	Analog Input 03[-]
Digital Ground	61	27	N.C.	Analog Ground (for AI)	8	42	Analog Ground (for AI)
N.C.	60	26	N.C.	Analog Input 04[+]	9	43	Analog Input 04[-]
N.C.	59	25	N.C.	Analog Input 05[+]	10	44	Analog Input 05[-]
Digital Ground	58	24	N.C.	Analog Input 06[+]	11	45	Analog Input 06[-]
N.C.	57	23	N.C.	Analog Input 07[+]	12	46	Analog Input 07[-]
Analog Input 31[-]	56	22	Analog Input 31[+]	Analog Ground (for AI)	13	47	Analog Ground (for AI)
Analog Input 30[-]	55	21	Analog Input 30[+]	Analog Input 08[+]	14	48	Analog Input 08[-]
Analog Input 29[-]	54	20	Analog Input 29[+]	Analog Input 09[+]	15	49	Analog Input 09[-]
Analog Input 28[-]	53	19	Analog Input 28[+]	Analog Input 10[+]	16	50	Analog Input 10[-]
Analog Ground (for AI)	52	18	Analog Ground (for AI)	Analog Input 11[+]	17	51	Analog Input 11[-]
Analog Input 27[-]	51	17	Analog Input 27[+]	Analog Ground (for AI)	18	52	Analog Ground (for AI)
Analog Input 26[-]	50	16	Analog Input 26[+]	Analog Input 12[+]	19	53	Analog Input 12[-]
Analog Input 25[-]	49	15	Analog Input 25[+]	Analog Input 13[+]	20	54	Analog Input 13[-]
Analog Input 24[-]	48	14	Analog Input 24[+]	Analog Input 14[+]	21	55	Analog Input 14[-]
Analog Ground (for AI)	47	13	Analog Ground (for AI)	Analog Input 15[+]	22	56	Analog Input 15[-]
Analog Input 23[-]	46	12	Analog Input 23[+]	Input Control External Sampling Start Trigger Input	23	57	Input Control External Sampling Stop Trigger Input
Analog Input 22[-]	45	11	Analog Input 22[+]	Input Control External Sampling Clock Input	24	58	Digital Ground
Analog Input 21[-]	44	10	Analog Input 21[+]	N.C.	25	59	N.C.
Analog Input 20[-]	43	9	Analog Input 20[+]	N.C.	26	60	N.C.
Analog Ground (for AI)	42	8	Analog Ground (for AI)	N.C.	27	61	Digital Ground
Analog Input 19[-]	41	7	Analog Input 19[+]	N.C.	28	62	N.C.
Analog Input 18[-]	40	6	Analog Input 18[+]	Digital Input 00	29	63	Digital Input 01
Analog Input 17[-]	39	5	Analog Input 17[+]	Digital Input 02	30	64	Digital Input 03
Analog Input 16[-]	38	4	Analog Input 16[+]	Digital Output 00	31	65	Digital Output 01
Analog Ground (for AI)	37	3	Analog Ground (for AI)	Digital Output 02	32	66	Digital Output 03
Analog Ground (for AI)	36	2	N.C.	Counter Gate Control Input	33	67	Counter Count-up Pulse Output
Analog Ground (for AI)	35	1	N.C.	Counter Clock Input	34	68	Reserved (Counter Input)

- The numbers in square brackets [] are pin numbers designated by HONDA TSUSHIN KOGYO CO.

Signal name	Description
Analog Input00 - Analog Input31	Analog input signal. The numbers correspond to channel numbers.
Analog Ground	Common analog ground for analog input signals.
AI External Start Trigger Input	External trigger input for starting analog input sampling.
AI External Stop Trigger Input	External trigger input for stopping analog input sampling.
AI External Sampling Clock Input	External sampling clock input for analog input.
Digital Input00 - Digital Input03	Digital input signal.
Digital Output00 - Digital Output03	Digital output signal.
Counter Gate Control Input	Gate control input signal for counter.
Counter Up Clock Input	Count-up clock input signal for counter.

Counter Output	Count output signal.
Digital Ground	Common digital ground for digital I/O signals, external trigger inputs, external sampling clock inputs, and counter I/O signals.
Reserved	Reserved pin.
N.C.	No connection to this pin.

CAUTION

- Do not connect any of the outputs and power outputs to the analog or digital ground. Neither connect outputs to each other. Doing either can result in a fault.
- If analog and digital ground are shorted together, noise on the digital signals may affect the analog signals. Accordingly, analog and digital ground should be separated.
- Leave "Reserved" pins unconnected. Connecting these pins may cause a fault in the product.

Differential Input (ADC-68M/96F)

CNB			CNA		
N.C.	B01	A01 N.C.	N.C.	A48	B48 N.C.
N.C.	B02	A02 N.C.	Analog Ground (for AI)	A47	B47 N.C.
N.C.	B03	A03 N.C.	N.C.	A46	B46 N.C.
N.C.	B04	A04 N.C.	Analog Ground (for AI)	A45	B45 N.C.
N.C.	B05	A05 N.C.	Analog Input 00[+]	A44	B44 Analog Input 08[+]
N.C.	B06	A06 N.C.	Analog Input 00[-]	A43	B43 Analog Input 08[-]
N.C.	B07	A07 N.C.	Analog Input 01[+]	A42	B42 Analog Input 09[+]
Digital Ground	B08	A08 Digital Ground	Analog Input 01[-]	A41	B41 Analog Input 09[-]
N.C.	B09	A09 N.C.	N.C.	A40	B40 N.C.
N.C.	B10	A10 N.C.	N.C.	A39	B39 N.C.
N.C.	B11	A11 N.C.	Analog Input 02[+]	A38	B38 Analog Input 10[+]
N.C.	B12	A12 N.C.	Analog Input 02[-]	A37	B37 Analog Input 10[-]
N.C.	B13	A13 N.C.	Analog Input 03[+]	A36	B36 Analog Input 11[+]
N.C.	B14	A14 N.C.	Analog Input 03[-]	A35	B35 Analog Input 11[-]
N.C.	B15	A15 N.C.	Analog Ground (for AI)	A34	B34 Analog Ground (for AI)
N.C.	B16	A16 N.C.	Analog Ground (for AI)	A33	B33 Analog Ground (for AI)
N.C.	B17	A17 N.C.	Analog Input 04[+]	A32	B32 Analog Input 12[+]
N.C.	B18	A18 N.C.	Analog Input 04[-]	A31	B31 Analog Input 12[-]
N.C.	B19	A19 N.C.	Analog Input 05[+]	A30	B30 Analog Input 13[+]
N.C.	B20	A20 N.C.	Analog Input 05[-]	A29	B29 Analog Input 13[-]
Analog Ground (for AI)	B21	A21 Analog Ground (for AI)	N.C.	A28	B28 N.C.
Analog Ground (for AI)	B22	A22 Analog Ground (for AI)	N.C.	A27	B27 N.C.
Analog Input 31[-]	B23	A23 Analog Input 23[-]	Analog Input 06[+]	A26	B26 Analog Input 14[+]
Analog Input 31[+]	B24	A24 Analog Input 23[+]	Analog Input 06[-]	A25	B25 Analog Input 14[-]
Analog Input 30[-]	B25	A25 Analog Input 22[-]	Analog Input 07[+]	A24	B24 Analog Input 15[+]
Analog Input 30[+]	B26	A26 Analog Input 22[+]	Analog Input 07[-]	A23	B23 Analog Input 15[-]
N.C.	B27	A27 N.C.	Analog Ground (for AI)	A22	B22 Analog Ground (for AI)
N.C.	B28	A28 N.C.	Analog Ground (for AI)	A21	B21 Analog Ground (for AI)
Analog Input 29[-]	B29	A29 Analog Input 21[-]	N.C.	A20	B20 N.C.
Analog Input 29[+]	B30	A30 Analog Input 21[+]	N.C.	A19	B19 N.C.
Analog Input 28[-]	B31	A31 Analog Input 20[-]	Digital Input 00	A18	B18 Digital Output 00
Analog Input 28[+]	B32	A32 Analog Input 20[+]	Digital Input 01	A17	B17 Digital Output 01
Analog Ground (for AI)	B33	A33 Analog Ground (for AI)	Digital Input 02	A16	B16 Digital Output 02
Analog Ground (for AI)	B34	A34 Analog Ground (for AI)	Digital Input 03	A15	B15 Digital Output 03
Analog Input 27[-]	B35	A35 Analog Input 19[-]	N.C.	A14	B14 N.C.
Analog Input 27[+]	B36	A36 Analog Input 19[+]	N.C.	A13	B13 N.C.
Analog Input 26[-]	B37	A37 Analog Input 18[-]	N.C.	A12	B12 N.C.
Analog Input 26[+]	B38	A38 Analog Input 18[+]	N.C.	A11	B11 N.C.
N.C.	B39	A39 N.C.	N.C.	A10	B10 N.C.
N.C.	B40	A40 N.C.	N.C.	A09	B09 N.C.
Analog Input 25[-]	B41	A41 Analog Input 17[-]	Digital Ground	A08	B08 Digital Ground
Analog Input 25[+]	B42	A42 Analog Input 17[+]	Input Control External Sampling Clock Input	A07	B07 N.C.
Analog Input 24[-]	B43	A43 Analog Input 16[-]	Input Control External Sampling Stop Trigger Input	A06	B06 N.C.
Analog Input 24[+]	B44	A44 Analog Input 16[+]	Input Control External Sampling Start Trigger Input	A05	B05 N.C.
N.C.	B45	A45 Analog Ground (for AI)	Counter Clock Input	A04	B04 N.C.
N.C.	B46	A46 N.C.	Reserved (Counter Input)	A03	B03 N.C.
N.C.	B47	A47 Analog Ground (for AI)	Counter Gate Control Input	A02	B02 N.C.
N.C.	B48	A48 N.C.	Counter Count-up Pulse Output	A01	B01 N.C.

- The numbers in square brackets [] are pin numbers designated by HONDA TSUSHIN KOGYO CO.

Signal name	Description
Analog Input00 - Analog Input31	Analog input signal. The numbers correspond to channel numbers.
Analog Ground	Common analog ground for analog input signals.
AI External Start Trigger Input	External trigger input for starting analog input sampling.
AI External Stop Trigger Input	External trigger input for stopping analog input sampling.
AI External Sampling Clock Input	External sampling clock input for analog input.
Digital Input00 - Digital Input03	Digital input signal.
Digital Output00 - Digital Output03	Digital output signal.
Counter Gate Control Input	Gate control input signal for counter.
Counter Up Clock Input	Count-up clock input signal for counter.
Counter Output	Count output signal.
Digital Ground	Common digital ground for digital I/O signals, external trigger inputs, external sampling clock inputs, and counter I/O signals.
Reserved	Reserved pin.
N.C.	No connection to this pin.

CAUTION

- Do not connect any of the outputs and power outputs to the analog or digital ground. Neither connect outputs to each other. Doing either can result in a fault.
- If analog and digital ground are shorted together, noise on the digital signals may affect the analog signals. Accordingly, analog and digital ground should be separated.
- Leave "Reserved" pins unconnected. Connecting these pins may cause a fault in the product.

Connecting Analog Input Signal

Single-ended Input

Single-ended Input Connection (Flat Cable)

The following figure shows an example of flat cable connection. Each signal source is connected to one analog input channel and the signal common to analog ground pin of CN1.

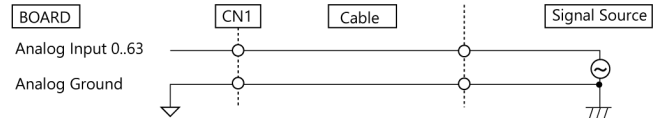

Single-ended Input Connection (Shielded Cable)

The following figure shows an example of shielded cable connection. When the distance between the signal source and the product is long or you want to increase the noise tolerance, a shield cable is suggested.

Connect the signal by the core wire and common signal by the shield braids.

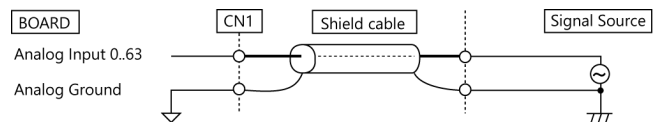

CAUTION

- When a frequency of 1MHz or higher is contained in the source signal, the cross talk between channels may occur.
- If the product and the signal source receive noise or the distance between the product and the signal source is too long, data may not be input properly.
- An input analog signal should not exceed the maximum input voltage (relate to the product analog ground). If it exceeds the maximum voltage, the product may be damaged.
- Connect all the unused analog input channels to analog ground.
- In the channel switching, the multiplexer does the electrical charge and discharge on the internal capacitor according to the signal voltage. Therefore, the voltage from the previous switching state may go into the next channel. It might cause the error of the signal source action. If this occurs, insert a high-speed amplifier as a buffer between the signal source and the analog input pin to reduce the fluctuation.
- An input pin may fail to obtain input data normally when the signal source connected to the pin has high impedance. If this is the case, change the signal source to one with lower output impedance or insert a high-speed amplifier buffer between the signal source and the analog input pin to reduce the effect.

Differential Input

Differential Input Connection (Flat Cable)

The following figure shows an example of flat cable connection. Each signal source is connected to a [+] pin of analog input channel and the signal common of this source to the [-] pin of this input channel of CN1. In addition, the signal common must be connected to the pin of the analog ground of CN1 by a third wire.

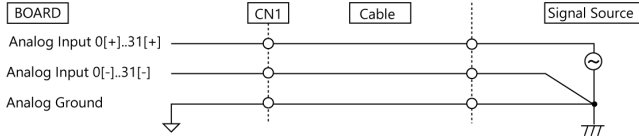

Differential Input Connection (Shielded Cable)

The following figure shows an example of shielded cable connection. When the distance between the signal source and the product is long or you want to increase the noise tolerance, a shield cable connection is preferred. Each signal source is connected to a [+] pin of analog input channel and the signal common of this source to the [-] pin of this input channel of CN1. In addition, the signal common must be connected to the pin of the analog ground of CN1 by the shielded braids.

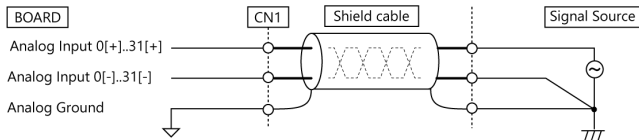

CAUTION

- When a frequency of 1MHz or higher is contained in the source signal, the cross talk between channels may occur.
- The input data would be uncertain if the analog ground is not connected.
- If the product and the signal source receive noise or the distance between the product and the signal source is too long, data may not be input properly.
- The input voltage from the [+] input or [-] input should not exceed the maximum input voltage (based on the product analog ground). If it exceeds the maximum voltage, the product may be damaged.
- Because the input data will be uncertain if the [+] pin or the [-] pin of CN1 is not connected, all the unused input pins of CN1 should be connected to the analog ground, AGND.
- In the channel switching, the multiplexer does the electrical charge and discharge on the internal capacitor according to the signal voltage. Therefore, the voltage from the previous switching state may go into the next channel. It might cause the error of the signal source action. If this occurs, insert a high-speed amplifier as a buffer between the signal source and the analog input pin to reduce the fluctuation.
- An input pin may fail to obtain input data normally when the signal source connected to the pin has high impedance. If this is the case, change the signal source to one with lower output impedance or insert a high-speed amplifier buffer between the signal source and the analog input pin to reduce the effect.

Counter input signal control

The counter gate control input (see Connector Pin Assignment in Chapter3) enables or disables the external clock input to the counter. You can use this function to control the external clock input to the counter. The external clock input to the counter is enabled when the input is "High" and disabled when the input is "Low". As the pin has an internal pull-up on the product, the default if not connected is "High". As a result, the external clock for the counter is enabled if this pin is not connected.

CAUTION

- Do not short the output signals to analog ground, digital ground, and/or power line. Doing so may damage the product.
- If connected to each output, a pull-up resistor must be about 10 kΩ to pull up with a 3.3V power source.

Circuit Block Diagram

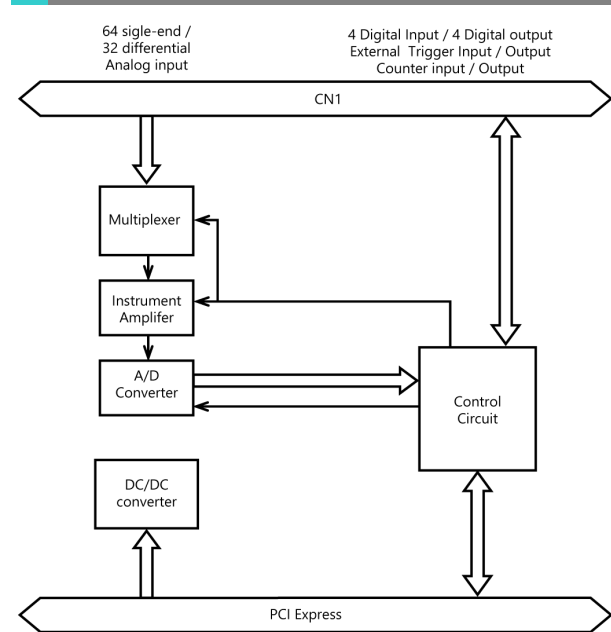

Differences between this product and our earlier models

The differences between this product's specifications and those of products from other series are shown below.

AI-1664UG-PE and AIO-163202UG-PE

Item	AI-1664UG-PE	AIO-163202UG-PE
Analog Input channel	64ch (Single-Ended Input), 32ch (Differential Input)	32ch (Single-Ended Input), 16ch (Differential Input)
Analog Input External status output signal	No	2 LVTTTL level Sampling clock output, etc.
Analog output	No	Yes
Digital input Number of input/output channels	4 inputs, 4 outputs (The number of channels is fixed and cannot be changed via software.)	16 (The number of channels can be set to either 16 input channels, 8 input channels and 8 output channels, or 16 output channels via software.)
Counter Number of channels	1ch	2ch
Bus master DMA channels	1ch (1ch for analog input)	2ch (1ch for analog input, 1ch for analog output)
Current consumption (Max.)	3.3VDC 1800mA	3.3VDC 2500mA, 12VDC 500mA
Weight	130g	140g

Digital I/O signals, Counter signals and Control signals Connection

The following sections show examples of how to connect digital I/O signals, counter I/O signals, and other control I/O signals (external trigger input signals, sampling clock input signals, etc.).

All the digital I/O signals and control signals are LVTTTL level signals.

Digital Input Connection

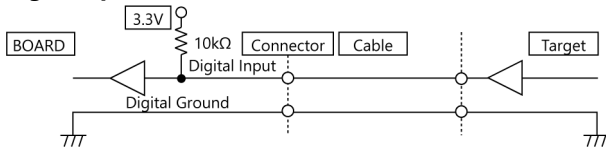

Digital Output Connection

