

N Series for USB  
Isolated Analog Output Unit  
(±10V Voltage Output)  
**AO-1604VIN-USB**  
(0 - 20mA Current Output)  
**AO-1604AIN-USB**



\* The photograph is a AO-1604VIN-USB.  
\* Specifications, color and design of the products are subject to change without notice.

**Features**

<AO-1604VIN-USB>  
4 channels of analog output (voltage output) with high accuracy, and 4 channels of digital input and output respectively are contained. Analog output (10μsec, 16bit, 4ch), digital input and output (Input: TTL level 4 channels, Output: Open-collector 4 channels) are equipped. The analog output supports the ±10V voltage output bipolar.

<AO-1604AIN-USB>  
4 channels of analog output (current output) with high accuracy, and 4 channels of digital input and output respectively are contained. Analog output (20μsec, 16bit, 8ch), digital input and output (Input: TTL level 4 channels, Output: Open-collector 4 channels) are equipped. The analog output supports the 0-20mA current output.

<Common>

**Buffer memory available in FIFO format**

This product contains buffer memory (8K data) which can be used in FIFO format. You can perform analog output in the background, independent of software and the current status of the PC.

**Sampling can be driven by a clock or by various triggers**

Sampling can be started and stopped by software and external (timing of control signals input from external) triggers. The sampling period can be controlled by the internal clock (high-precision timer included in the product).

**Isolated from the bus by a digital isolator**

This product isolates the PC from analog output as well as digital I/O by a digital isolator, which improves the noise performance.

**Open collector output for digital output**

The use of open collector output ensures digital outputting with TTL or 12-24 V power by the power of the external device.

**Compact design not restricting installation location (188.0(W)×78.0(D)×30.5(H))**

Compact design of 188.0(W) × 78.0(D) × 30.5(H) does not require special installation location.

This product is an analog output unit supporting USB2.0 to provide the output function of analog signal from USB port on the computer. Compact design, (188.0(W)×78.0(D)×30.5(H)mm), features flexibility in installation. The product can be set on the floor, wall, and inside the console or equipment with the DIN rail.

For AO-1604VIN-USB, 4 channels of 16-bit analog output, and digital input and output (4 channels respectively) are equipped, and these circuits are isolated from the computer. As the analog output supports differential input, accurate measurement can be performed even when potential differences with the signal source occur. The output range supports ±10V voltage output.

As for AO-1604AIN-USB, 4 channels of 16-bit analog output, and digital input and output (4 channels respectively) are equipped, and these circuits are isolated from the computer. The output range supports 0-20mA current output.

\* The contents in this document are subject to change without notice.  
\* Visit the CONTEC website to check the latest details in the document.  
\* The information in the data sheets is as of July 2024.

**Compatible to USB2.0/USB1.1**

Compatible to USB2.0/USB1.1 and capable to achieve high speed transfer at High Speed (480 Mbps)

**Diverse installations such as screw fastening, magnet, DIN rail are possible**

Installation on the floor / wall / ceiling is possible by screw fastening, magnet, rubber feet, etc. In addition, DIN rail mounting mechanism is equipped as standard with the product, making it easy to install the product within the panel or the device.

**Easy-to-wire terminal connector adopted**

Adoption of terminal connector (with screws) enables to achieve easy wiring.

**Windows compatible driver software is provided**

Using the provided driver software API-AIO(WDM) for USB makes it possible to create applications of Windows.

In addition, a Diagnostic Program to confirm the hardware operations is supplied as well.

**LabVIEW is supported by a plug-in of dedicated library**

Using the dedicated library allows a user to create each application for LabVIEW.

**Software-based calibration function**

Calibration of analog output can be all performed by software. Apart from the adjustment information prepared before shipment, additional adjustment information can be stored according to the use environment.

**Packing List**

Product...1	Rubber feet...4
Setup Guide...1	AC Adapter...1
Warranty Certificate...1	AC Cable...1
Serial Number Label...1	
Interface Connector...3	
USB Cable (1.8m)...1	
USB Cable Attachment on the main unit's side...1	

## Specifications

### Function Specifications

Item		AO-1604VIN-USB	AO-1604AIN-USB
Analog output	Isolated specification	Bus-Isolated	
	Output channel	4ch	
	Output range	Voltage: Bipolar $\pm 10V$	Current: 0 - 20mA
	Maximum output current	$\pm 5mA$	-
	Output impedance	1 $\Omega$ or less	-
	Resolution	16bit	
	Non-linear error *1	$\pm 15LSB$	$\pm 15LSB$ *2
	Settling time	10 $\mu sec$ (Max.)	20 $\mu sec$ (Max.)
	Buffer memory	8K data	
	Conversion start trigger	Software / external trigger	
	Conversion stop trigger	Number of sampling times / external trigger / soft-ware	
	External start signal	TTL level (Rising or falling edge can be selected to the DI00-pin by software)	
	External stop signal	TTL level (Rising or falling edge can be selected to the DI01-pin by software)	
	External clock signal	TTL level (Rising or falling edge can be selected to the DI02-pin by software)	
Digital input	Number of input channels	4ch	
	Input type	Bus-isolated TTL level input (Negative logic) *3*4	
Digital output	Number of output channels	4ch	
	Output format	Bus-isolated open collector output (Negative logic) *3	
	Output rating	Output voltage: 30VDC (Max.)	Output current: 40mA (par channel) (Max.)
USB	Bus specification	USB Specification 2.0/1.1-compliant	
	USB transfer rate *5	12Mbps (Full-speed), 480Mbps (High-speed)	
	USB connector	USB mini B connector	
	Power supply	Self-power	
Power supply	Input voltage range	12 - 24VDC $\pm 10\%$	
	Current consumption (Max.)	12VDC 250mA, 24VDC 150mA	
	Power supply connector	European type terminal 3.5mm pitch 3-pin jack connector	
Common section	Interface connector	European type terminal 3.5mm pitch 10-pin jack connector	
	Dielectric strength	500VAC	
	Physical dimensions (mm)	188.0(W) $\times$ 78.0(D) $\times$ 30.5(H) (No projection included)	
	Weight	250g (Not including the USB cable, attachment, connector)	
	The length of cable (supplied)	USB cable(Type A - mini-B type) 1.8m	

- \*1 The non-linearity error means an error of approximately 0.1% occurs over the maximum range at -20°C and 60°C ambient temperature.
- \*2 When using a power supply with a ripple of 3mV (P-P) for the load side power supply (ADVANTEST R6161)
- \*3 Data "0" and "1" correspond to the High and Low levels, respectively.
- \*4 The DI00 / DI01 / DI02-pin of digital input cannot be used simultaneously with External start signal/ External stop signal/ External clock signal.
- \*5 The USB transfer speed depends on the host PC environment used (OS and USB host controller).

### Installation Environment Requirements

Item		AO-1604VIN-USB	AO-1604AIN-USB
Operating ambient temperature		-20 - +60°C *6	
Operating ambient humidity		10 - 90%RH (No condensation)	
Floating dust particles		Not to be excessive	
Corrosive gases		None	
Line-noise resistance *7	Line noise	AC Line/ $\pm 2kV$ Signal Line / $\pm 1kV$ (IEC61000-4-4 Level 3, EN61000-4-4 Level 3)	
	Static electricity resistance	Touch / $\pm 4kV$ (IEC61000-4-2 Level 2, EN61000-4-2 Level 2) Air / $\pm 8kV$ (IEC61000-4-2 Level 3, EN61000-4-2 Level 3)	
Vibration resistance	Sweep resistance	10 - 57Hz /semi-amplitude vibration 0.15mm, 57 - 150Hz/2.0G 40minutes each in X, Y, and Z directions (JIS C60068-2-6-compliant, IEC60068-2-6-compliant)	
	Shock resistance	147m/s <sup>2</sup> (15G)/11ms/half-sine shock (JIS C 60068-2-27-compliant, IEC 60068-2-27-compliant)	
Standard		VCCI Class A, FCC Class A, CE Marking (EMC Directive Class A, RoHS Directive), UKCA	

- \*6 When using the supplied AC adaptor POA 201-10-2, it is 0 - 40°C.
- \*7 When using the supplied AC adaptor POA 201-10-2.

### AC adapter environmental condition (environmental specification)

Item	Specifications
Input voltage range	90 - 264VAC
Rated input current	300mA
Number of frequency	50 - 60Hz
Rated output voltage	12.0VDC
Rated output current	1.0A (Max)
Physical dimensions (mm)	47.5(W) $\times$ 75(D) $\times$ 27.3(H) (No protrusions)
Weight	175g
Operating temperature	0 - 40°C
Operating humidity	20 - 80%RH (No condensation)
Life expectancy *8	1.5 years (at the ambient temperature 40 °C when 100VAC is input and 1.0A is output) 4 years (at the ambient temperature 40 °C when 100VAC is input and 0.5A is output)
Allowable time of short interruption	20ms (Max.) (When 100VAC is input and 0.55A is output) *9
Floating dust particles	Not to be excessive
Corrosive gases	None
Voltage compatible to the supplied AC cable	125VAC 7A

- \*8 Life expectancy is four years when using this product.
- \*9 When short interruption occurs and the product causes an error, unplug and plug the AC adapter.

## Physical Dimensions

### Product

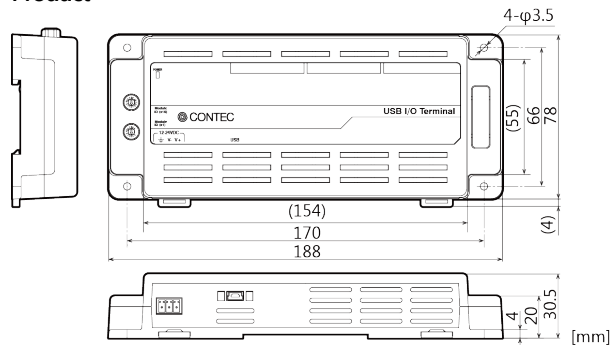

### Physical dimensions of the supplied AC adapter (POA201-10-2)

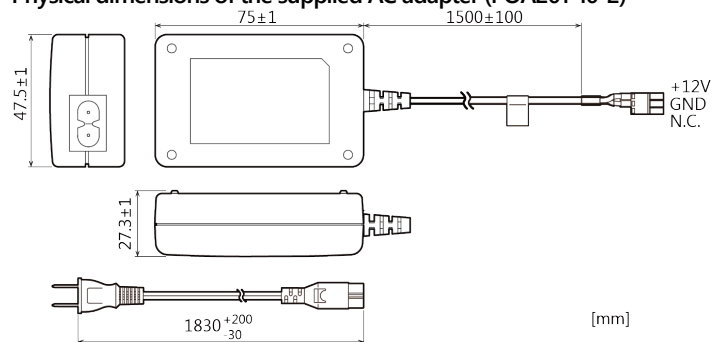

## Support Software

You can use CONTEC support software according to your purpose and development environment. For more details on the supported OS, applicable languages, or to download the latest version of software, visit the CONTEC Web site.

Name	Contents	How to get
Driver software API-AIO(WDM) for USB	The API-AIO(WDM) is the Windows version driver software that provides products in the form of Win32 API functions (DLL). Various sample programs such as Visual Basic and Visual C++, etc and diagnostic program useful for checking operation is provided.	Download from the CONTEC website
LabVIEW VI Library for Data Acquisition DAQfast for LabVIEW	This is a data collection library to use our devices in the LabVIEW by National Instruments. With Polymorphic VI, our design enables a LabVIEW user to operate seamlessly. Our aim is for the customers to perform easily, promptly what they wish to do.	Download from the CONTEC website

## Optional Products

Product Name	Model type	Applications	Description
AC adapter	POA201-10-2 *1	External power supply for self-power	Input: 90 - 264VAC, Output: 12VDC 1.0A
DIN rail fitting power supply	CPS-PWD-90AW24-01 *2		90W (Input: 100-240VDC, Output: 12VDC 3.8A)
	CPS-PWD-30AW24-01 *2		30W (Input: 100-240VDC, Output: 12VDC 1.3A)
	CPS-PWD-15AW12-01 *2	15W (Input: 100-240VDC, Output: 12VDC 1.3A)	
Magnet	CPS-MAG01-4	Magnets for product installation	Magnet (Four Piece Set)

\*1 The operating ambient temperature is 0 to 40 °C. It is the same adapter included in this package.

\*2 The operating ambient temperature is -20 to 70 °C.

Visit the CONTEC website for the latest optional products.

## Signal Layout on the Interface Connector

The product can be connected to an external device using two 10-pin connectors included in the package.

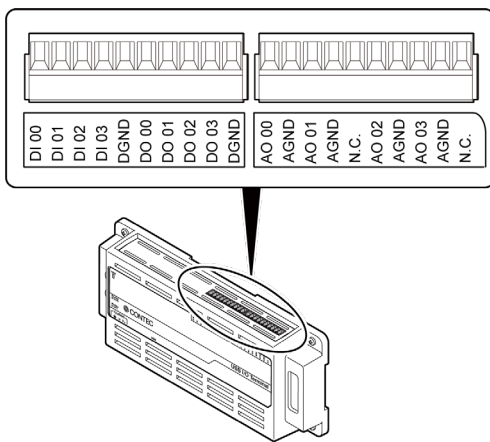

DI 00 -- DI 03	Digital input pins. The numbers correspond to input bits.
DO 00 -- DO 03	Digital output pins. The numbers correspond to output bits.
DGND	This is a digital ground and shares channels of I/O signals.
AO 00 -- AO 03	Analog output pins. The numbers correspond to channel numbers.
AGND	This is an analog ground and shares channels of analog output signals.
N.C.	This pin is left unconnected.

## Connecting Cable

### Analog Output Cable

Use the analog output cable listed below.

Applicable wire	AWG28-16
Cable Length	For AO-1604VIN-USB : Within 1.5 meters * If higher accuracy is required, the cable length should be 0.5 meters or shorter. For AO-1604AIN-USB : Within 20 meters

### Digital I/O Cable

Use the digital I/O cable listed below.

Applicable wire	AWG28-16
Cable Length	Within 1.5 meters

## Connecting Analog Output Signal (AO-1604VIN-USB)

The AO-1604VIN-USB has 4 channels of AO that supports voltage output.

### Connection Example of Voltage Output

#### - Example of flat cable connection

Connect the voltage output pins of each channel of the interface connector to the analog ground. Use a flat cable to connect to the input of the external device and the ground.

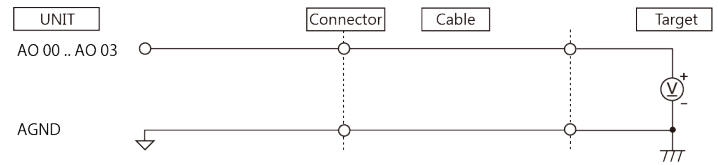

#### - Example of coaxial cable connection

A coaxial cable can be used in situations where the product is at a relatively large distance from the external device or when the noise immunity of the product must be improved.

In this case, the voltage output and the analog ground for each channel are connected to the input of the external device and the ground by using the core wire and the shield braid of the coaxial cable.

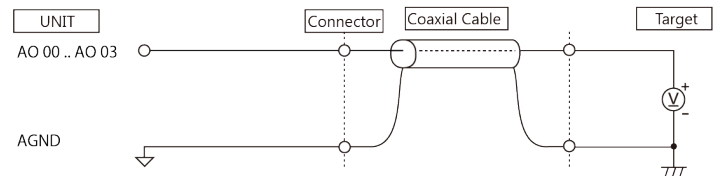

#### CAUTION

- To avoid any malfunction, the voltage output signal should not be connected to the analog ground.
- To avoid any malfunction, the voltage output signal should not be connected to another analog output signal or the output signal of an external device.
- To avoid any malfunction, the internet connector plug should not be attached or detached when the power for the product or the external device is on. This may result in the product damages.
- In situations where the connecting cable is subject to the effects of noise, the accurate voltage output can fail. The connecting cable should be installed away from any source of noise.
- The maximum current capacity for a voltage output signal is ±5mA. To avoid any malfunction, do not connect an external device that generates a load exceeding this range.
- In situations where the connecting cable is excessively long, the accurate voltage output can fail. The connection cable should therefore be within 1.5 meters.
- An undefined value might be output momentarily when the power is turned on.

## Connecting Analog Output Signal (AO-1604AIN-USB)

The AO-1604VIN-USB has 4 channels of AO that supports current output.

### Connection Example of Current Output

#### - Floating Load and Fixed Load

Two types of connection methods can be employed: fixed load and floating load.

"Floating load" is employed when the analog ground is connected to the negative side of an external power supply. "Fixed load" is employed when the analog ground is connected to the load.

If the product is used as a load resistance, multiple current loops can be implemented by using the same power supply.

The use of current output requires an external power supply (12 - 24V). In such a case, a power supply with a small ripple should be used in order to avoid an adverse impact on the conversion accuracy due to a large power supply ripple.

The load resistance  $R_L$  that is connected to the current output of each channel should be between 100 and 500Ω, including the output impedance of the connected device and wire resistance.

**- The Power Composition of Connecting to Multiple Load Resistors**

	Single Power Supply	Multiple Power Supplies
Floating Load	○	○
Fixed Load	X	○

**- Example of flat cable connection**

Use a flat cable to connect the current output and the analog ground of each channel to the load resistance  $R_L$ .

**- Connecting to a Floating Load**

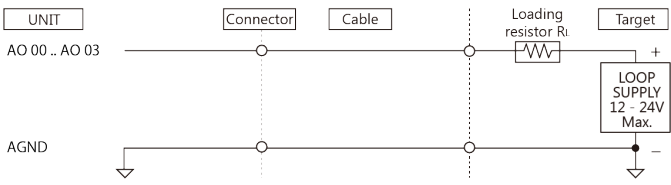

**- Connecting to a Fixed Load**

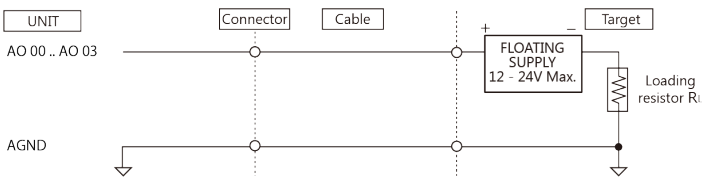

**- Example of coaxial cable connection**

A coaxial cable can be used in situations where the product is at a relatively large distance from the external device or when the noise immunity of the product must be improved.

In this case, the current output and the analog ground for each channel are connected to the load resistance  $R_L$  of the external device by using the core wire and the shield braid of the coaxial cable.

**- Connecting to a Floating Load**

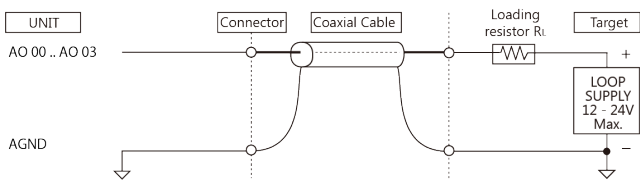

**- Connecting to a Fixed Load**

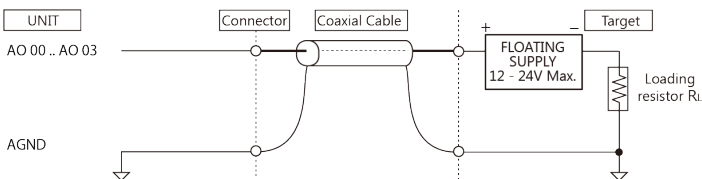

**- Example of connecting to multiple floating load resistors**

As shown below, connect the current output and the analog ground of each channel to the load resistance  $R_L$ .

Multiple current loops can be implemented by using the same power supply.

**- Connecting to a Floating Load**

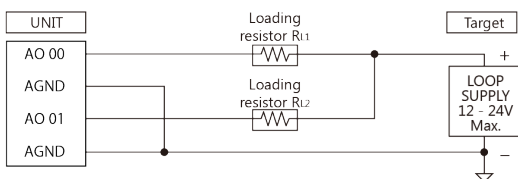

**- Connecting to a Fixed Load**

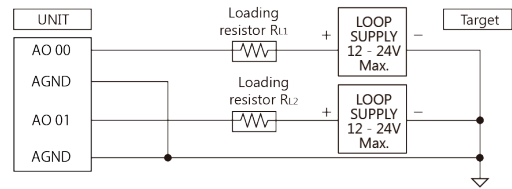

**- Example of connecting to multiple fixed load resistors**

As shown below, connect the current output and the analog ground of each channel to the load resistance  $R_L$ .

Multiple current loops can be implemented by using the same power supply.

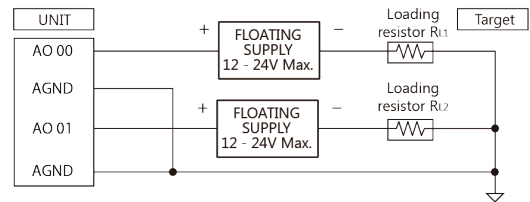

**CAUTION**

- To avoid any malfunction, the current output signal should not be connected to the analog ground or the external device.
- In situations where the connecting cable is subject to the effects of noise, the accurate current output can fail. The connecting cable should be installed away from any source of noise.
- To avoid any malfunction, the interface connector plug should not be attached or detached when the power for the product or the external device is on. This may result in the product damages.

**Digital I/O signals Connection**

Digital I/O signals can be used as control I/O signals (external trigger input signals, sampling clock input signals, etc.). The following section shows examples of how to connect signals.

**Input Circuit**

The following is a digital I/O circuit of the interface (connector) part. External digital signals given to signal input section are TTL level, and each signal is taken to a PC using negative logic. Each signal input section is pulled-up in this product, therefore, outputs of relay contacts or semiconductor switch can be connected directly between this signal input and signal common.

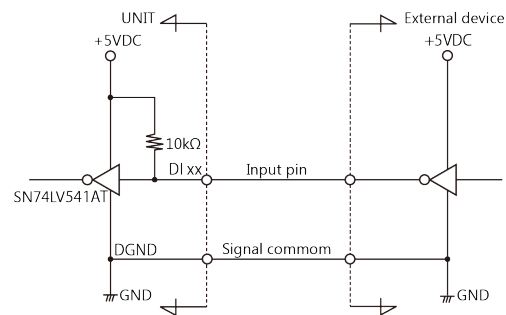

\*Input pins are indicated as DI xx. xx corresponds to input bits

DI 00 - DI02 can be used as control signals listed below. However, when using them as control signals, they cannot be used as general-purpose digital inputs.

- DI 00: External Start Signal Input
- DI 01: External Stop Signal Input
- DI 02: External Clock Signal Input

**Example Connection with switch**

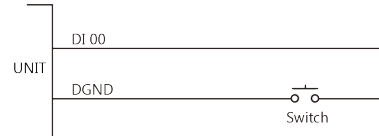

When switch is "ON", the corresponding bit is "1".  
When switch is "OFF" in contrast, the corresponding bit is "0".

### Output Circuit

The following is an output circuit of the interface (connector) part. Signal output section is an open-collector, and each signal is sent to external devices using negative logic. Outputting by open-collector makes outputting in accordance with the power of the external devices. Note that each signal output section is not pulled-up in this product, therefore, pull up at the external device side.

**CAUTION**

- Do not short the output signals to analog ground, and/or digital ground. Doing so may damage the product.
- When supplying power of 12-24VDC power (such as the AC adapter), all output will be OFF.

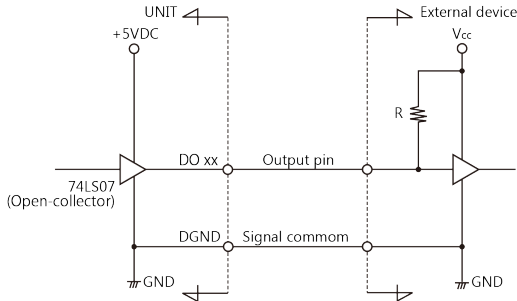

\*Output pins are indicated as DO xx. xx corresponds to output bits.

### Example Connection with LED

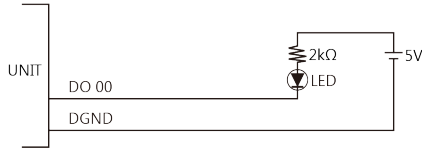

When "1" is output to a relevant bit, the corresponding LED comes on.  
When "0" is output to the bit, in contrast, the LED goes out.

## Setting Switches

With the two setting switches, the host computer distinguishes and keeps track of the devices of same model by assigning Module IDs to them. Factory setting "00" can be used when only one device per model is connected to one computer. Each device should be assigned a unique Module ID in the range of 00 - 7Fh when several devices with the same model are being connected.

"x16" and "x1" represent upper four bits and lower four bits of Module ID respectively.

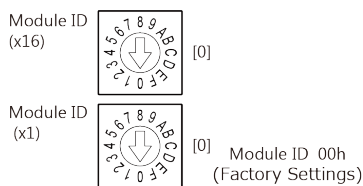

Module ID	Description
00 - 7Fh	It is a setting range for module IDs.
FFh	This is used only when upgrading the firmware.

**CAUTION**

When setting with Module ID(x1) = F, Module ID(x16) = F, Module ID is only used for upgrading the firmware. This setting cannot be used to distinguish or keep tracks of the devices.