

Raspberry Pi Expansion Card
Solid State Relay
CPI-RRY-16

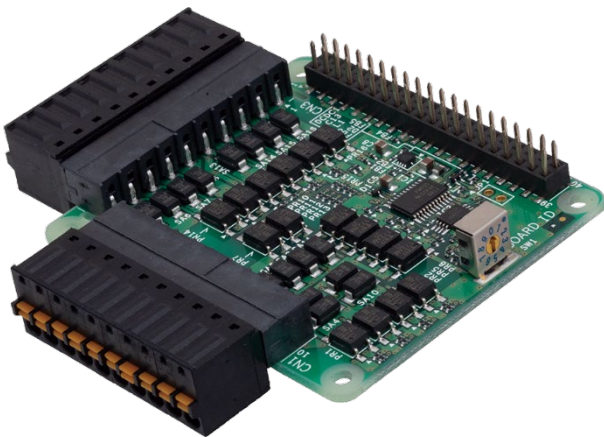

* Specifications, color and design of the products are subject to change without notice.

Features

Solid State Relay contact output

The product is equipped with 16 solid state relay contact outputs. Because the design consists of 4 separate commons, they can each individually support a different external power supply. The card is capable of a 30 VDC output withstand voltage.

Bus isolation with solid state relays

Because the Raspberry Pi GPIO 40-pin connector and output interface are isolated with solid state relays, the card offers excellent noise resistance.

Built-in TVS diodes for surge voltage protection in the output circuit

To protect against surge voltage, TVS diodes are connected to the output circuits. The maximum rated output is 30 VDC, 200 mA per channel.

Connectivity for up to 8 cards

Connect up to 8 expansion cards of the same series. Use the Board ID setting switch on the main body to identify connected expansion cards.

Adaptable to a wide range of temperature between -20 and +60°C

The product is capable of operating in the temperature between -20 and +60°C. It can be installed in the various environments.

No electrolytic capacitor

Without an electrolytic capacitor, which has a limited life, we are creating the product with a longer life.

Linux compatible driver software

Using the digital I/O driver API-DIO(LNX) makes it possible to create applications of Linux.

This product is an expansion card that adds a solid state relay output interface to the Raspberry Pi.

Because the design consists of 4 separate commons, they can each individually support a different external power supply.

- * The contents in this document are subject to change without notice.
- * Visit the CONTEC website to check the latest details.
- * Visit the CONTEC website to check the latest OS.
- * The information in the data sheets is as of July, 2022.

Specification

Function specification

Item	Description	
Output		
Output type	Solid state relay contact output	
Number of output signal channels	16 (1 common for 4 channels)	
Isolation	Solid state relay isolation	
Voltage Resistance	AC1000Vrms	
Output rating	Output Voltage	30VDC (Max.)
	Output Current	200mA (Max.)
ON resistance	10Ω or less	
OFF leak current	5μA or less	
Surge protector	zener diodes SMAJ40CA (Littelfuse) or equivalent to it	
Response time	2.5msec or less	
Allowable distance of signal extension	Approx. 50m (depending on wiring environment)	
Digital I/O control IC	TCA9535(TI) or equivalent to it	
Bus specification	I2C bus (I2C1)	
Max. module count for connection	Maximum of 8cards can be install in a same system. (Excluding RAS cards)	
Connector	2 pieces 3.81mm pitch 10-pin terminal	
Applicable wire	AWG28 - 16	
Physical dimensions (mm)	65.0(W) x 56.5(D) (No projection included) Spacer height : 12.5mm	
Weight	50g	

Installation Environment Requirements

Item	Description	
Operating Temperature	-20 - +60°C	
Storage Temperature	-20 - +60°C	
Humidity	10 - 90%RH (No condensation)	
Floating dust particles	Not to be excessive	
Corrosive gases	None	
Line-noise resistance *1	Line noise	Signal Line /±1kV (IEC61000-4-4 Level 3, EN61000-4-4 Level 3)
	Static electricity resistance	Indirect discharge /±4kV (IEC61000-4-2 Level 3, EN61000-4-2 Level 3)
Vibration resistance	Sweep resistance	10 - 57Hz/semi-amplitude vibration 0.15mm, 57 - 150Hz/2.0G 40minutes each in X, Y, and Z directions (JIS C60068-2-6-compliant, IEC60068-2-6-compliant)
Shock resistance		15G half-sine shock for 11ms in X, Y, and Z directions (JIS C 60068-2-27 -compliant, IEC 60068-2-27 -compliant)
Standard		VCCI Class A, FCC Class A, CE Marking (EMC Directive Class A, RoHS Directive), UKCA

*1 When using the CPI-RAS.

Support Software

You can use CONTEC support software according to your purpose and development environment.

For more details on the supported OS, applicable languages, or to download the latest version of software, visit the CONTEC Web site.

Name	Contents	How to get
Driver software API-DIO(LNX)	This is the Linux version driver software provided in API function formats. The software includes various sample programs such as gcc (C, C++) and Python programs.	Download from the CONTEC website

List of Option

Product Name	Model type	Description
RAS card	CPI-RAS	RAS/RTC function, 8 to 28 VDC input function expansion
DIN RAIL ADAPTER	CPI-DIN01	

* Information about the option products, see the Contec's website.

External Dimensions

Main body only

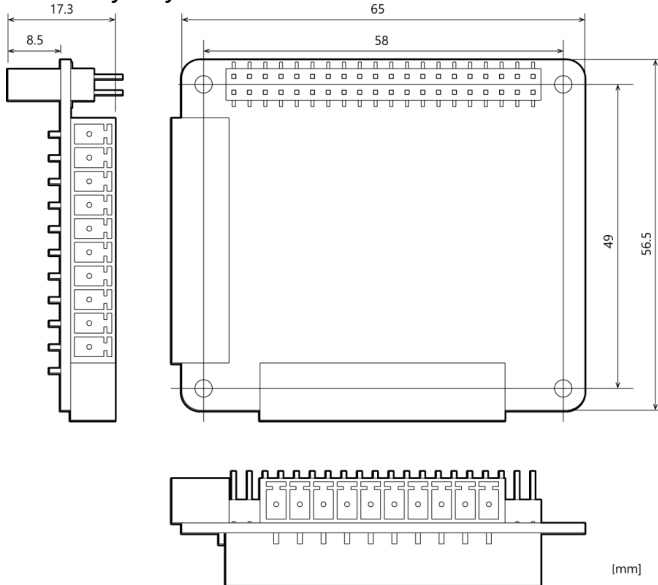

With connector attached

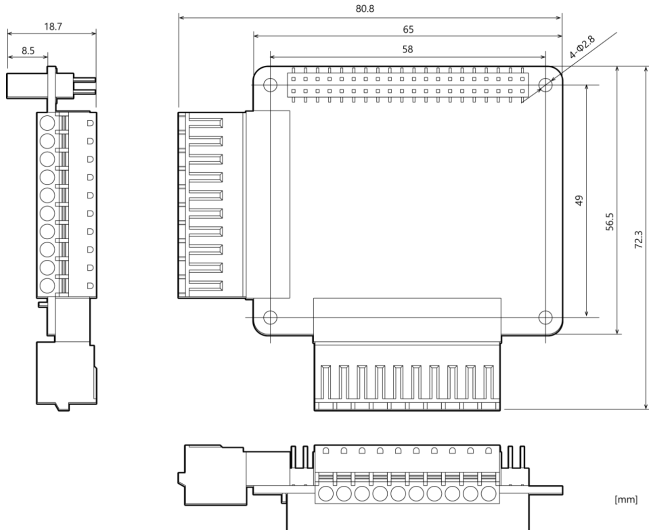

Packing List

- Product [CPS-RRY-16]...1
- 10-pin Connector...2 (Attached to the product)
- 40-pin Pin-header...1
- Plastic spacer for CPU card...1
- Hexagonal spacers...4 (Height 12.5mm)
- Three-point Sems Screw...4
- Nuts...4
- Product Guide & Warranty Certificate...1
- Serial Number Label ...1

Circuit Block Diagram

CPI-RRY-16

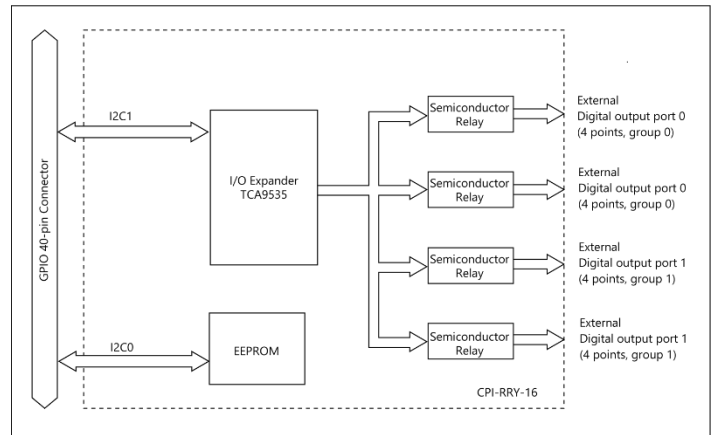

Component Name

Component name of the product is shown in Figure.

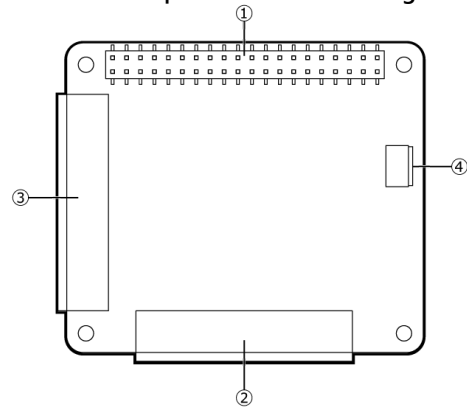

No.	Name	Function
1	GPIO 40 pin connector	This connector is used to connect to a Raspberry Pi or an expansion card.
2	Interface Connector 1	This connector is used for digital output. It uses the included 10-pin connector.
3	Interface Connector 2	This connector is used for digital output. It uses the included 10-pin connector.
4	Board ID setting switch	This setting switch is used to identify I2C communication expansion cards. The switch is used to change the I2C address.

Description of Product Components

GPIO 40 pin connector

This connector is used to connect to a Raspberry Pi or an expansion card.

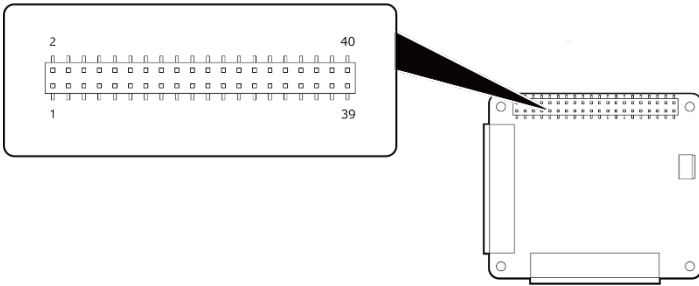

Pin Assignment

Pin No.	Signal Name	Description	Pin No.	Signal Name	Description
1	3.3V Power	3.3V power supply	2	5V Power	5V power supply
3	GPIO 2(I2C1 SDA)	I2C1 SDA	4	5V Power	5V power supply
5	GPIO 3(I2C1 SCL)	I2C1 SCL	6	Ground	GND
7	GPIO 4(GPCLK0)	(Don't use)	8	GPIO 14(UART TX)	(Don't use)
9	Ground	GND	10	GPIO 15(UART RX)	(Don't use)
11	GPIO 17	(Don't use)	12	GPIO 18(PCM CLK)	(Don't use)
13	GPIO 27	(Don't use)	14	Ground	GND
15	GPIO 22	(Don't use)	16	GPIO 23	(Don't use)
17	3.3V Power	3.3V power supply	18	GPIO 24	(Don't use)
19	GPIO 10(SPI0 MOSI)	(Don't use)	20	Ground	GND
21	GPIO 9(SPI0 MISO)	(Don't use)	22	GPIO 25	(Don't use)
23	GPIO 11(SPI0 SCLK)	(Don't use)	24	GPIO 8(SPI0 CE0)	(Don't use)
25	Ground	GND	26	GPIO 7(SPI0 CE1)	(Don't use)
27	GPIO 0(EEPROM SDA)	I2C0 SDA	28	GPIO 1(EEPROM SCL)	I2C0 SCL
29	GPIO 5	(Don't use)	30	Ground	GND
31	GPIO 6	(Don't use)	32	GPIO 12(PWM0)	(Don't use)
33	GPIO 13(PWM1)	(Don't use)	34	Ground	GND
35	GPIO 19(PCM FS)	(Don't use)	36	GPIO 16	(Don't use)
37	GPIO 26	(Don't use)	38	GPIO 20(PCM DIN)	(Don't use)
39	Ground	GND	40	GPIO 21(PCM DOUT)	(Don't use)

Interface connector 1

This connector is used for digital input/output (Port 0). It uses the included 10-pin connector.

Connector type: DEGSON 15EDGKD-3.81-10P-13-00A(H)

PHOENIX CONTACT FK-MCP 1.5/10-ST-3.81 (or equivalent)

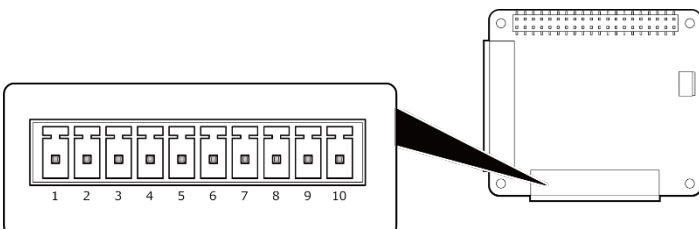

Pin Assignment

Pin No.	Signal Name	Description
1	COM1	This is the contact output common. This common is shared between DO10 and DO13 signals.
2	DO13	This is the contact output. This contact is connected to the input signals of other devices.
3	DO12	This is the contact output. This contact is connected to the input signals of other devices.
4	DO11	This is the contact output. This contact is connected to the input signals of other devices.
5	DO10	This is the contact output. This contact is connected to the input signals of other devices.
6	COM0	This is the contact output common. This common is shared between DO00 and DO03 signals.
7	DO03	This is the contact output. This contact is connected to the input signals of other devices.
8	DO02	This is the contact output. This contact is connected to the input signals of other devices.
9	DO01	This is the contact output. This contact is connected to the input signals of other devices.
10	DO00	This is the contact output. This contact is connected to the input signals of other devices.

Interface connector 2

This connector is used for digital input/output (Port 1). It uses the included 10-pin connector.

Connector type: DEGSON 15EDGKD-3.81-10P-13-00A(H)

PHOENIX CONTACT FK-MCP 1.5/10-ST-3.81 (or equivalent)

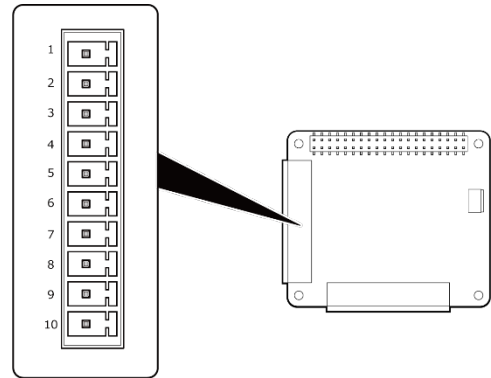

Pin Assignment

Pin No.	Signal Name	Description
1	COM3	This is the contact output common. This common is shared between DO30 and DO33 signals.
2	DO33	This is the contact output. This contact is connected to the input signals of other devices.
3	DO32	This is the contact output. This contact is connected to the input signals of other devices.
4	DO31	This is the contact output. This contact is connected to the input signals of other devices.
5	DO30	This is the contact output. This contact is connected to the input signals of other devices.
6	COM2	This is the contact output common. This common is shared between DO20 and DO23 signals.
7	DO23	This is the contact output. This contact is connected to the input signals of other devices.
8	DO22	This is the contact output. This contact is connected to the input signals of other devices.
9	DO21	This is the contact output. This contact is connected to the input signals of other devices.
10	DO20	This is the contact output. This contact is connected to the input signals of other devices.