

Digital I/O Board for PCI
DIO-6464T2-PCI



- * Specifications, color and design of the products are subject to change without notice.
- * The contents in this document are subject to change without notice.
- * Visit the CONTEC website to check the latest details in the document.
- * The information in the data sheets is as of July, 2022.

Features

Unisolated TTL level input, unisolated open-collector output
DIO-6464T2-PCI has the 64ch of unisolated TTL level inputs and 64ch of unisolated open-collector outputs whose response speed is 200nsec.

Output rating : max 30VDC, 40mA per pin.

You can use 16 input signals as interrupt request signals.
You can use 16 input signals as interrupt request signals and also disable or enable the interrupt in bit units and select the edge of the input signals, at which to generate an interrupt.

This product has a digital filter to prevent wrong recognition of input signals from carrying noise or a chattering.

This product has a digital filter to prevent wrong recognition of input signals from carrying noise or a chattering. All input terminals can be added a digital filter, and the setting can be performed by software.

Windows/Linux compatible driver libraries are attached.
Using the attached driver library API-PAC(W32) makes it possible to create applications of Windows/Linux. In addition, a diagnostic program by which the operations of hardware can be checked is provided.

LabVIEW is supported by a plug-in of dedicated library VI-DAQ.
Using the dedicated library VI-DAQ makes it possible to create each application for LabVIEW.

Packing List

- Board [DIO-6464T2-PCI] ...1
- First step guide ... 1
- Disk *1 [API-PAC(W32)] ...1
- Warranty Certificate ...1
- Serial Number Label...1

*1 The bundled disk contains the driver software and User's Guide.

This product is a PCI bus-compliant interface board used to provide a digital signal I/O function on a PC.

DIO-6464T2-PCI features 64 unisolated TTL level inputs and 64 unisolated open-collector outputs. You can use 16 input signals as interrupt inputs. In addition, the digital filter function to prevent wrong recognition of input signals is provided.

Windows/Linux driver is bundled with this product.

Possible to be used as a data recording device for LabVIEW, with dedicated libraries.

Specification

Item	Specification	
Input		
Input format	Unisolated TTL level input (Negative logic *1)	
Number of input signal channels	64channels (16channels of them are available for interrupts) (1 common)	
Input resistance	Pull up 10kΩ (1TTL load)	
Interrupt	16 interrupt input signals are arranged into a single output of interrupt signal INTA. An interrupt is generated at the rising edge (HIGH-to-LOW transition) or falling edge (LOW-to-HIGH transition).	
Response time	200nsec within	
Output		
Output format	Unisolated open collector output (Negative logic *1)	
Number of output signal channels	64channels (1 common)	
Output rating	Output voltage	30VDC (Max.)
	Output current	40mA (per channel) (Max.)
Response time	Within 200nsec (change by pull-up resistor value)	
Common		
External supply capable current (Max.)	5VDC 1A *3	
Allowable distance of signal extension	Approx. 1.5m (depending on wiring environment)	
I/O address	Any 32-byte boundary	
Interrupt Level	1 level use	
Max. board count for connection	16 boards including the master board	
Power consumption (Max.)	5VDC 450mA *4	
Operating condition	0 - 50°C, 10 - 90%RH (No condensation)	
Bus specification	PCI (32bit, 33MHz, Universal key shapes supported *2)	
Dimension (mm)	121.69(L) x 105.68(H)	
Connector	100 pin 0.8mm pitch connector [F (female) type] x 2 HDRA-E100W1LFDT1EC-SL+[HONDA TSUSHIN KOGYO CO., LTD.] equivalent to it	
Weight	100g	
Standard	VCCI Class A, CE Marking (EMC Directive Class A, RoHS Directive), UKCA	

- *1 Data "0" and "1" correspond to the High and Low levels, respectively.
- *2 This board requires power supply at +5V from an expansion slot (it does not work on a machine with a +3.3V power supply alone).
- *3 Because it supplies the +5V power supply from an expansion slot, the external supply capable current depends on the PC.
- *4 The power consumption does not include it in the external supply capable current.

* I-00 - I-17 can be used as interrupt signal.

I-00 - I-77	64 input signal pins. Connect output signals from the external device to these pins.
O-80 - O-F7	64 output signal pins. Connect these pins to the input signal pins of the external device.
Vcc	Output +5V. The current that can be supplied is 1A(Max). The permitted current per pin of connector is 0.3A. Connect the number of pins required to supply the total current.
GND	This pin is connected to GND in the slot. The permitted current per pin of connector is 0.3A. Connect the number of pins required to supply the total current for the 64 outputs.
N.C.	This pin is left unconnected.

Pin Assignments of Optional Connector PCB100/96PS or PCB100WS

The figure below shows the correspondence between the option cable pins and signals.

< Pin assignments for connecting a PCB100/96PS or PCB100WS to the DIO-6464T2-PCI >

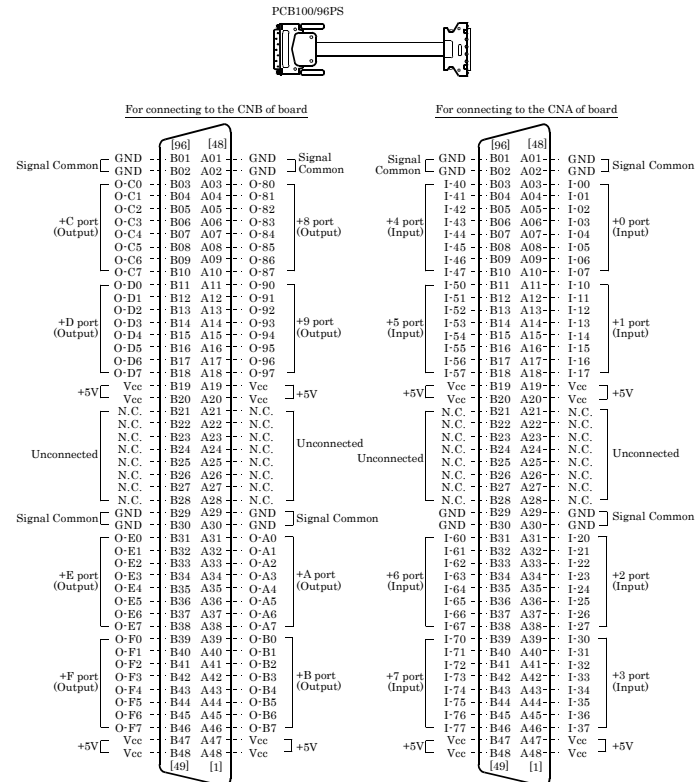

* The numbers in square brackets [] are pin numbers designated by HONDA TSUSHIN KOGYO CO., LTD.

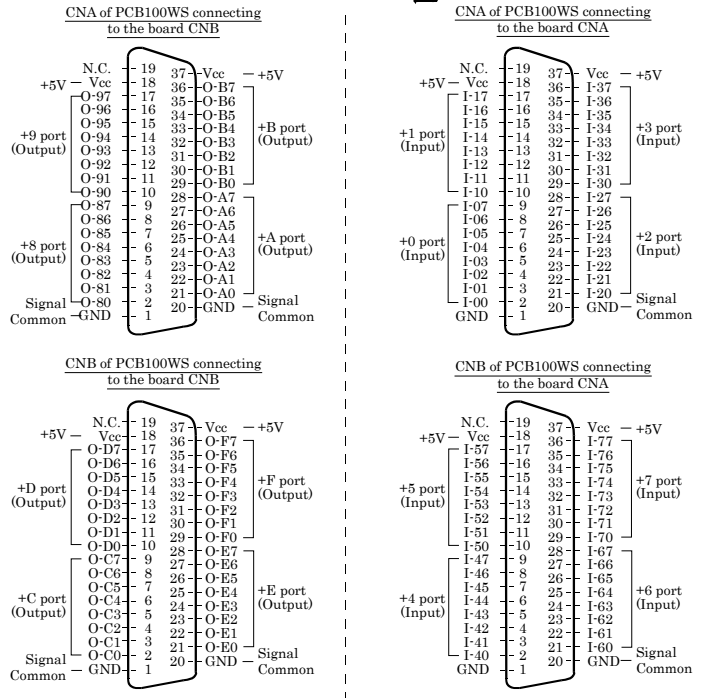
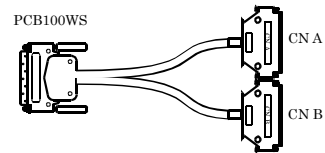

Connecting Input Signals

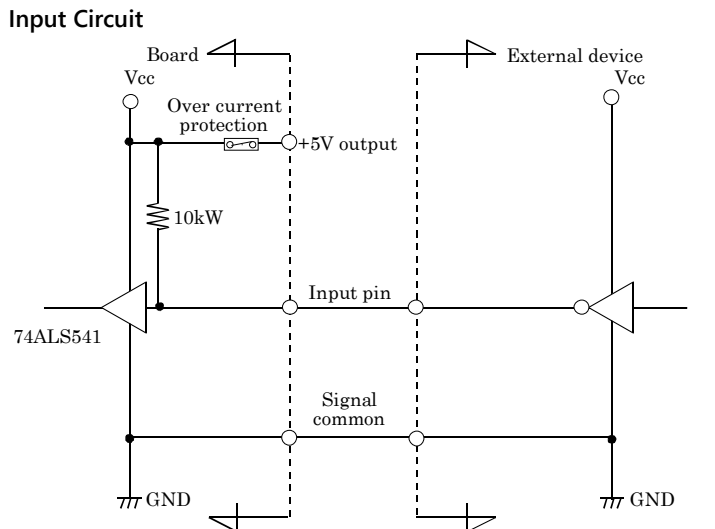

* I-xx represents an input pin. One over current protection is connected for Vcc(+5V) terminal.

The input circuits of interface blocks of the < DIO-6464T2-PCI > is illustrated in Figure. External digital signals given to signal inputs are TTL levels. The individual input signals are passed to the personal computer as negative logic signals. As each of the signal inputs is pulled up internally, the output of a relay contact or semiconductor switch can be connected directly between the signal input and the signal common pin.

Connecting a Switch

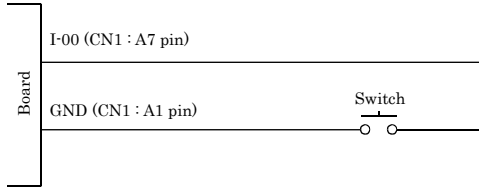

When the switch is ON, the corresponding bit contains 1.
When the switch is OFF, by contrast, the bit contains 0.

Connecting Output Signals

Output Circuit

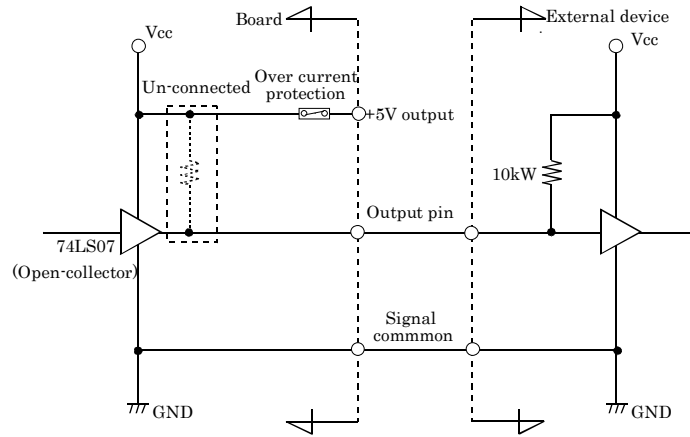

* O-xx represents an output pin.
One over current protection is connected for Vcc(+5V) terminal.

The output circuit of < DIO-6464T2-PCI > is illustrated in Figure. Signal outputs are open-collector outputs; individual output signals are sent to the external device as negative logic signals. Note that each signal output must be pulled up at the external device as it is not pulled up internally.

CAUTION

When the PC is turned on, all output are reset to OFF.

Connection to the LED

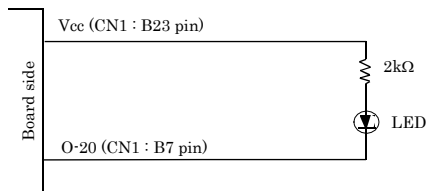

When "1" is output to a relevant bit, the corresponding LED comes on.
When "0" is output to the bit, in contrast, the LED goes out.

Block Diagram

